

DIE BAUTEILE / EINZELKOMPONENTEN

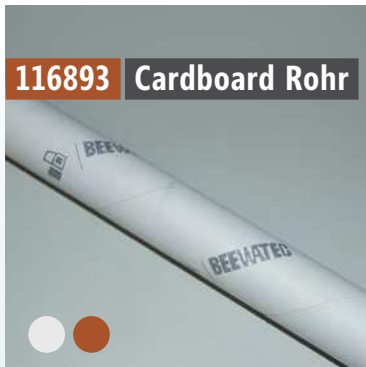

Papprohr,
Durchmesser: 28mm
Länge: 2m
VPE: 20 Stück / 40m



Pappwinkel,
40x40mm
Länge: 2m
VPE: 5 Stück / 10m



T-Verbinder
Gewicht: 30 g
VPE: 50 Stück

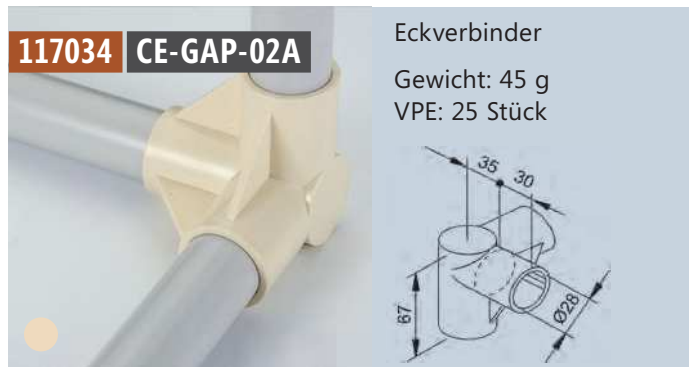
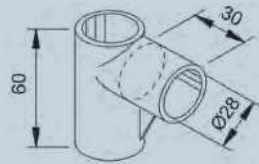

Eckverbinder
Gewicht: 45 g
VPE: 25 Stück

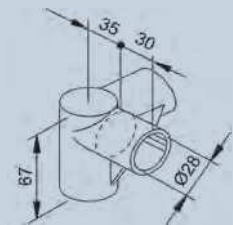

Kantenverbinder
Gewicht: 48 g
VPE: 25 Stück

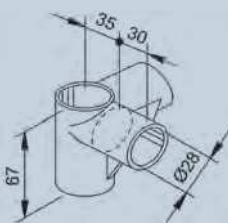

Außenkappe
Gewicht: 9 g
VPE: 300 Stück



Winkelverbinder
Gewicht: 32 g
VPE: 50 Stück

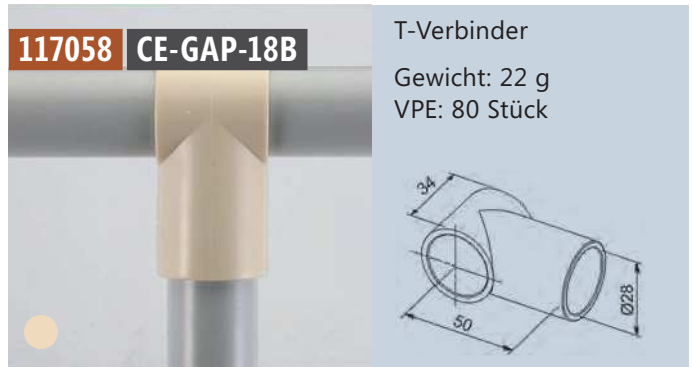
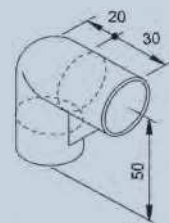

T-Verbinder
Gewicht: 22 g
VPE: 80 Stück

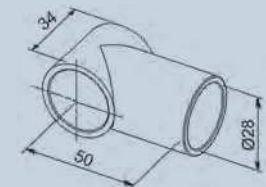

Clip-Rohrverbinder
Gewicht: 18 g
VPE: 100 Stück

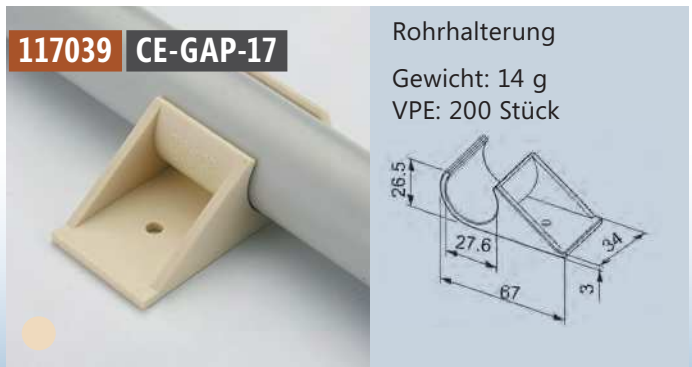
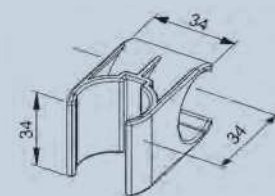

Rohrhalterung
Gewicht: 14 g
VPE: 200 Stück

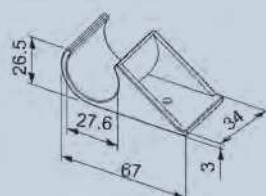

117167 CE-GAP-06



Halter für LA-C... und LA-D

Gewicht: 5g
VPE: 300 Stück

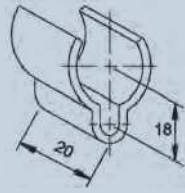

117041 CE-GAP-26B



Kreuzverbinder für Durchgangs-Stützrohr

Gewicht: 54 g
VPE: 25 Stück

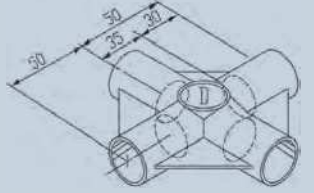

117168 CE-GAP-27A



Doppelverbinder für Stützrohr

Gewicht: 35 g
VPE: 50 Stück

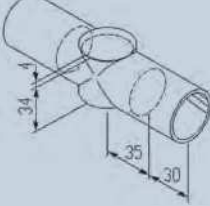

117042 CE-GAP-27B



Doppelverbinder für Durchgangs-Stützrohr

Gewicht: 33 g
VPE: 50 Stück

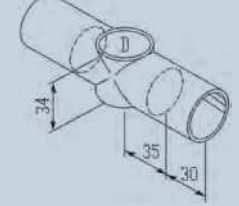

117169 CE-GAP-28A



Kantenverbinder für Stützrohr

Gewicht: 46 g
VPE: 30 Stück

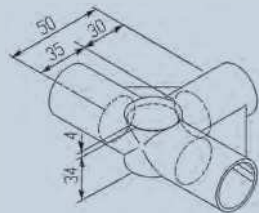

117170 CE-GAP-28B



Kantenverbinder für Durchgangs-Stützrohr

Gewicht: 44 g
VPE: 30 Stück

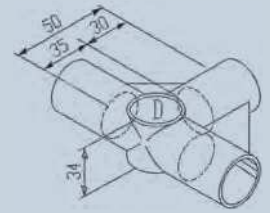

117046 CE-GAP-41



Querverbinder 45°

VPE: 50 Stück

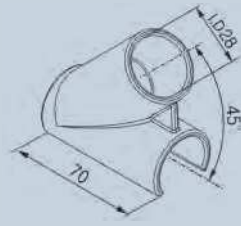

117171 CE-GAP-43



Querverbinder parallel

Gewicht: 28 g
VPE: 50 Stück

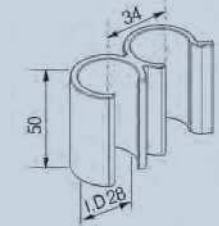

117040 CE-GAP-23-G

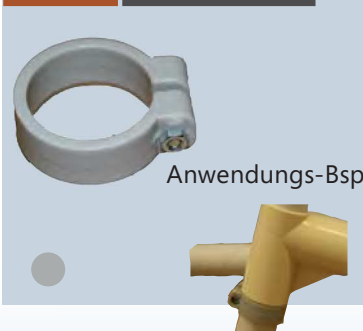

Kunststoff-Halter (Befestigungsmaterial Schraube SLK0320 und Mutter M03 separat bestellen)

Gewicht: 20 g
VPE: 100 Stück

Anwendungs-Bsp.:

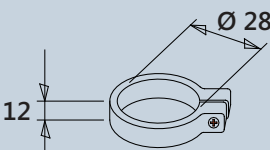

117043 CE-GAP-29B



T-Verbinder für Durchgangsrohr

Gewicht: 43 g
VPE: 30 Stück

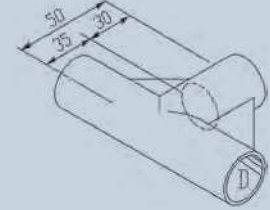

117059 CE-GAP-29A

T-Verbinder
 Gewicht: 45 g
 VPE: 30 Stück

117045 CE-GAP-31

Rohrabschluss zum Einhängen
 Gewicht: 20 g
 VPE: 70 Stück

117044 CE-GAP-30

Verstrebung für Durchgangsrohr
 Gewicht: 25 g
 VPE: 70 Stück

117061 CE-GAP-65

Kappe für Ecke
 Gewicht: 14g
 VPE: 16 Stück
 Maße ca. 70 x 46,5mm

117060 CE-GAP-64

Ecke
 Gewicht: 164g
 VPE: 12 Stück
 Maße ca. 116 x 116mm

116755 P363S-3

Rad, weiß (für Ecke)
 Raddurchmesser: 3"
 Radbreite: 25 mm
 Material: Nylon
 Gesamthöhe 94 mm
 VPE: 1 Stück

117047 CE-SG-01

Klemmstück für Platte
 VPE: 80 Stück
 Länge: 33 mm

100036 LA-D

Transparente Kunststofftaschen werden mit Halter GAP-06 am Rohr befestigt.
 Maße: 150 x 60 mm
 Gewicht: 12g
 VPE: 1 Stück

100059 LA-C A4

Transparente Kunststofftaschen werden mit Halter GAP-06 am Rohr befestigt.
 Maße: 300 x 220 mm
 Gewicht: 88g
 VPE: 1 Stück

115216 F 8454

Zuschnitt nach Wunsch
 5mm

117078 CBP 05

Zuschnitt nach Wunsch
 5mm

117156 Messer für Cardboard

Geriffeltes Messer zum schneiden der BeeCardboard Rohre.
 Klingenlänge: 12,5 cm

DIE STARTER-SETS

Bezeichnung	Artikel-Nr.	VPE Nachfüllpack	Starter-Set klein	Starter-Set groß
			Bestell-Nr. 117030	Bestell-Nr. 117031
			im Set enthaltene Mengen:	im Set enthaltene Mengen:
CE-GAP-01-i	117033	50	30	150
CE-GAP-02A-i	117034	25	10	75
CE-GAP-02B-i	117035	25	20	75
CE-GAP-03-i	117036	300	20	50
CE-GAP-05-i	117037	50	20	150
CE-GAP-06-i	117167	300	12	40
CE-GAP-16-i	117038	100	20	300
CE-GAP-17-i	117039	200	40	400
CE-GAP-18B-i	117058	80	30	240
CE-GAP-23-G	117040	100	30	300
CE-GAP-26B-i	117041	25	10	75
CE-GAP-27A-i	117168	50	10	150
CE-GAP-27B-i	117042	50	10	150
CE-GAP-28A-i	117169	30	10	90
CE-GAP-28B-i	117170	30	10	90
CE-GAP-29B-i	117043	30	10	90
CE-GAP-29A-i	117059	30	10	90
CE-GAP-30-i	117044	70	50	210
CE-GAP-31-i	117045	70	60	210
CE-GAP-41-i	117046	50	10	210
CE-GAP-43-i	117171	50	5	30
CE-GAP-64-BK	117060	12	4	12
CE-GAP-65-BK	117061	16	4	16
CE-SG-01 Zuschnitt	117047	80	20	80
LA-C A4	100059	1	3	10
LA-D	100036	1	5	20
P363S-3	116755	1	4	12
Cardboard-Rohr, 2m	116893	20	20	200
Cardboard-Winkel, 2m	116975	5	5	60
LEANbox Ecke, weiß	116702	40	20	40
LEANbox, Ecke schwarz	116703	40	20	40
LEANbox, Griff, weiß	117024	20	5	10
LEANbox, Griff, schwarz	117025	20	5	10
LEANbox Profil, 2m, weiß	117026	10	10	20
LEANbox Profil, 2m, schwarz	117155	10	10	20
Kartonplatte 970x1170mm	117078	10	5	20
Hohlkammerplatte, 5mm 970x1170mm	117162	1	1	3
Klebebandabroller	117157	1	1	1
Klebeband BEEWATEC	114121	1	1	3
Meterstab BEEWATEC	117065	1	1	3
Messer	117156	1	1	3

Alle Set-Teile werden in Kunststoff-Boxen der Serie **BEEpractical** mit Beschriftung angeliefert.
with boxes