



HOBELWELLENAGGREGAT – PREMIUM LINE MOULDER C

TECHNISCHE DATEN

Schmierung	Ölbad
max. Abtriebsdrehzahl n_2	10.000 min ⁻¹
Übersetzung ($n_1: n_2$)	1:0,9
max. Abtriebsdrehmoment M_2	25 Nm
Gewicht	ca. 7,5 kg
max. Werkzeugdurchmesser	Ø 125

STANDARDAUSFÜHRUNG

- 1  Maschinenanbindung
HSK - F63
- 2  Werkzeugaufnahme
Dorn Ø30, WZ-Länge 100 mm

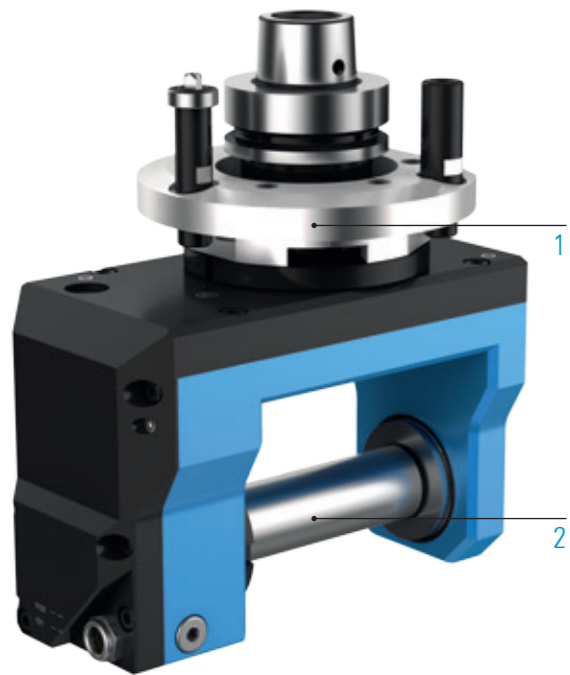

WEITERE OPTIONEN: MODULARER AUFBAU

1



MASCHINENANBINDUNG



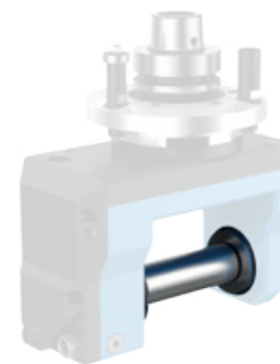

 Weitere Informationen S. 106

2



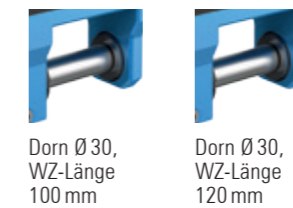



WERKZEUGAUFNAHME



 Weitere Dorndurchmesser und Werkzeuglängen auf Anfrage

BEARBEITUNG

-  Fräsen
-  Sägen
-  Hobeln
-  Bürsten

SPEZIFIKATIONEN

-  Anzahl
Werkzeugaufnahmen
-  Achswinkel
-  C-Winkel
-  Ölbadschmierung

VIDEO

 Aggregat – live in der Anwendung
QR Code scannen oder alternativ:
www.youtube.com/BENZWerkzeugsysteme

DIREKT BESTELLEN

 Anfrageformular:
www.benz-tools.de/de/produkte