

# Snap Action Switch Catalog

SWISS  
MADE



If your application depends on it.



# Index

<b>Table of Contents</b>	<b>03</b>
<b>The Company</b>	<b>04</b>
<b>The Products</b>	<b>05</b>
<b>Terminology</b>	<b>06</b>
<b>Installation Recommendations</b>	<b>11</b>
<b>Product Specifications</b>	
<b>Series MP40</b>	<b>14</b>
<b>Series MP90</b>	<b>22</b>
<b>Series MP110</b>	<b>28</b>
<b>Series MP210/220</b>	<b>38</b>
<b>Series MP215/225</b>	<b>46</b>
<b>Series MP300</b>	<b>50</b>
<b>Series MP400</b>	<b>58</b>
<b>Series MP500</b>	<b>64</b>

Design and specifications are subject to change for improvement without prior notice.

# The Company



Microprecision Electronics SA is a company of Swiss origin. Founded in 1956 in the center of Europe, close to Lake Geneva, the company started as a supplier for the Swiss watch industry. Its competencies in the manufacturing of precision parts and components led to the development of snap action microswitches with a large selection of precise actuators. During the following years Microprecision increased its product range with safety switches.

In 2008, Microprecision Electronics SA extended its presence in North America through the acquisition of Wilbrecht Electronics, a manufacturer of LED indicator lights and metal foil resistors, located in Minnesota.

Today, Microprecision Electronics SA manufactures at its locations in Switzerland and the United States. The product line consists of standard and customized microswitches, limit and safety switches as well as LED indicator lights. Products are sold through its distribution channel all over the world to customers in Europe, North America and Asia.



# The Products

The microswitches and safety switches are manufactured under an ISO 9001 certified quality system and are also approved to follow the international standards under UL, ENEC and CSA. The products are specifically designed for a low differential travel, a precise actuating point, wide operating temperature range and sealing up to IP68.

For these reasons, our products are used in the most demanding industrial applications: light actuating force for pressure switch applications, small differential travel in electromagnetic break control and IP68 for underwater switching applications are just some examples.

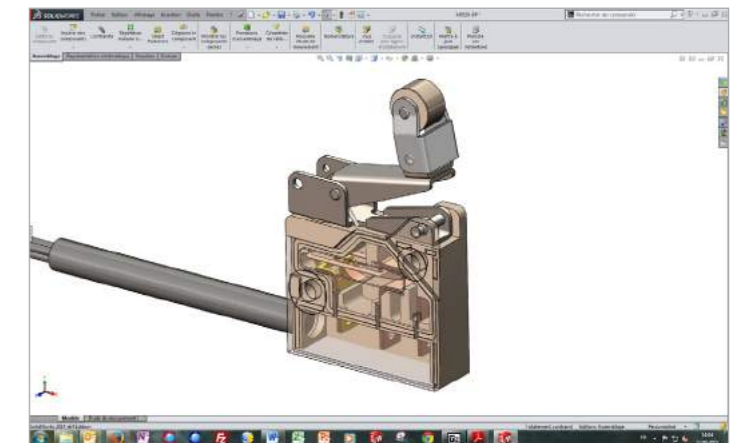

Since every company has needs that are specific to its own unique application, we offer our customers tailor-made products. Our experienced engineers use 3D design workstations and are able to make modifications to dimensions, choice of materials, switching parameters as well as design custom actuators.

In Microprecision Electronics SA you will find a partner to help solve your unique switch requirements from early design to final product.



# Terminology

## Contact variations

<b>SPST</b> Single-Pole Single-Throw Single-Break	<b>SPST</b> Single-Pole Single-Throw Double-Break	<b>SPST</b> Single-Pole Double-Throw Single-Break	<b>SPST</b> Single-Pole Double-Throw Double-Break

## Contact materials

The spring blade is made of copper/beryllium with the moving contact made of silver. The fixed NC and NO contacts are produced of a silver-copper bi-metal band. Those materials are used for standard applications under standard power.

For low power switching below 100 mA/24V, we recommend gold contacts to prevent any contact corrosion.

## Electrical function

Normally open NO (Normally Open) Contact open, force applied needs to be higher than the actuating force to close the contact	Normally closed NC (Normally Closed) contact closed without any force applied. Force applied needs to be higher than the actuating force to open.	Change-over Upon an applied force higher than the actuating force, the moving contact moves from NC to NO

## Contact Gap

The air gap between two contacts of different polarity when the circuit is open. The breaking power of a switch depends to a great extent on the distance between contacts. For a higher power rating the air gap needs to be increased to prevent any formation of an electrical arc.

The air gap may vary between 0.2mm and 0.8mm depending on the models. This parameter has a direct impact on the differential travel.

## Positions / Forces

### COMMAND CHARACTERISTICS TERMINOLOGY

ACTUATOR POSITIONS		ACTUATOR TRAVEL		ACTUATOR FORCES	
<b>Pr</b>	<b>Free Position</b> Position of actuator when no external force is applied to it.	<b>sa</b>	<b>Pre-Travel</b> Distance between the free position and the operating position.	<b>Fa</b>	<b>Actuating Force</b> That force which must be applied to the actuator to cause it to move from the free position (Pr) to the actuating position (Pa). Indicated in our literature for all actuators and basic models.
<b>Pa</b>	<b>Operating Position</b> Position of the actuator at the instant when an increasing applied force has just caused the snap action mechanism to operate.	<b>sr</b>	<b>Over-Travel</b> Distance between the operating position and the total travel position.	<b>Fr</b>	<b>Release Force</b> The value to which the applied force must be reduced in order to permit the switch to return to its initial position after operation.
<b>Pfc</b>	<b>Total Travel Position</b> Position of the actuator when an increasing applied force has caused it to move to the actual limit of the permissible travel. To avoid damage, actuator must not be forced past this point.	<b>sd</b>	<b>Differential Movement</b> Distance between the operating position and the release position.	<b>Fd</b>	<b>Differential force</b> The difference between the actuating force and the release force.
<b>Pdr</b>	<b>Release Position</b> Position of the actuator at the instant when a decreasing applied force allows the snap action mechanism to return to its initial state.	<b>st</b>	<b>Total Travel</b> Distance which is the sum of the pre-travel and the over-travel. The distance between the free position and the total travel position at the actual limits of permissible travel.	<b>Fct</b>	<b>Total Over-Travel Force</b> Force necessary to move the actuator from the free position to the total travel position.

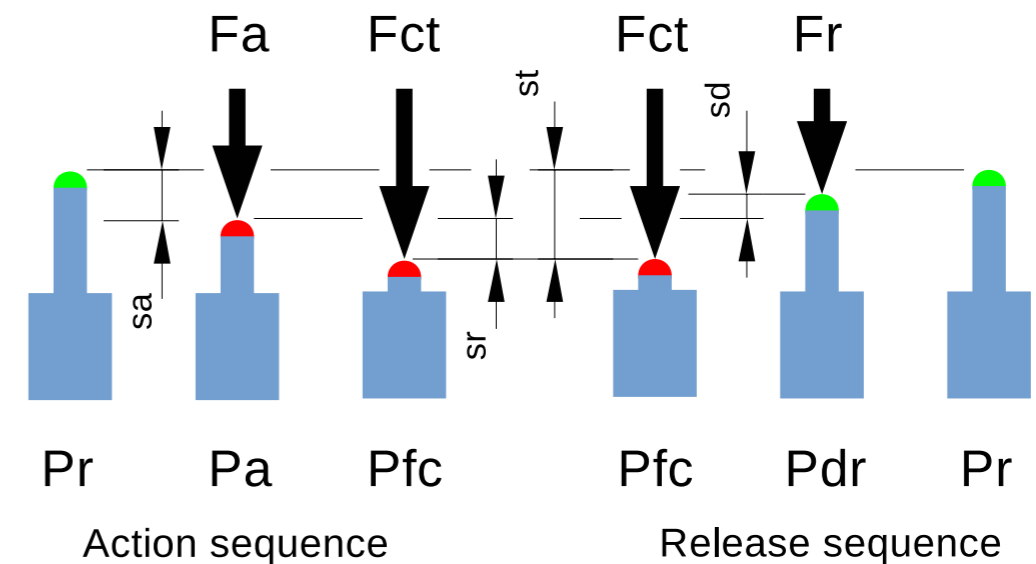

DIAGRAM APPLIED FORCE-TRAVEL

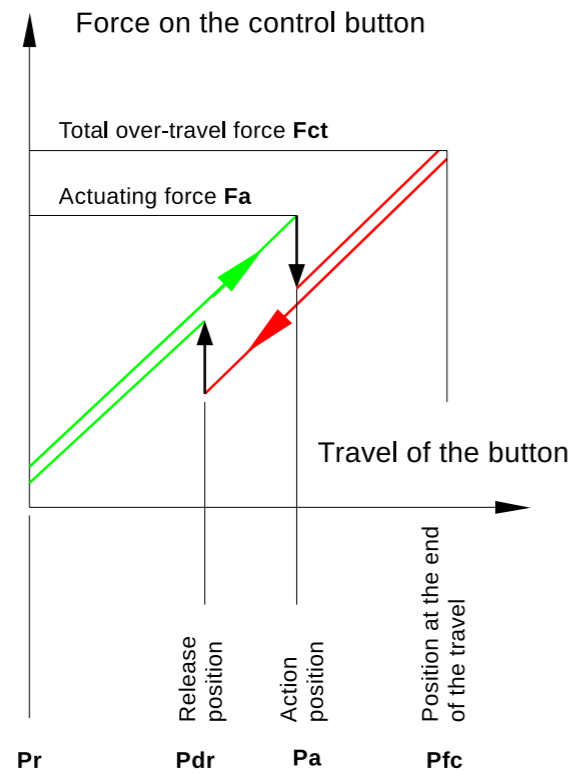
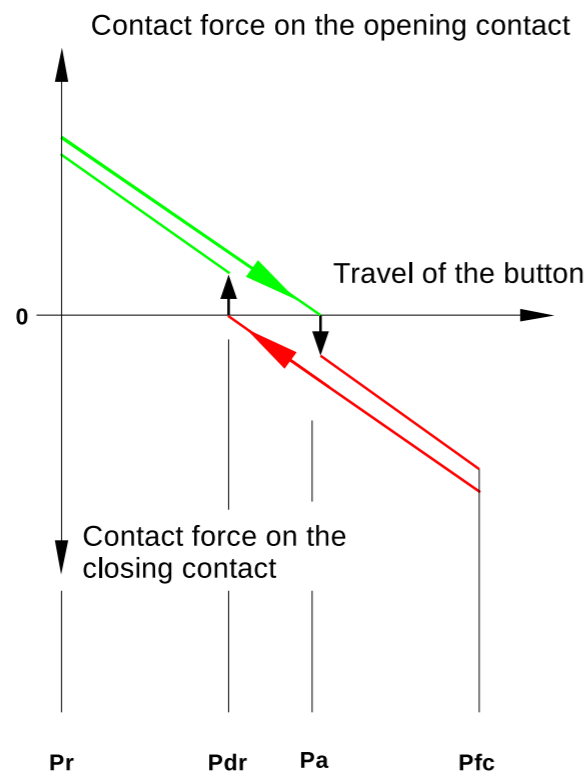

DIAGRAM CONTACT FORCE-TRAVEL



## Bouncing

When closing a contact of a snap action switch, you may observe a bouncing of the mobile contact on the fixed contact before establishing a firm contact. These bounces may last between 0.2 and 4 ms depending on the type.

When used under low power, this bouncing may cause malfunctioning of the connected electronics. If this happens an added low-pass filter may eliminate/reduce this effect.

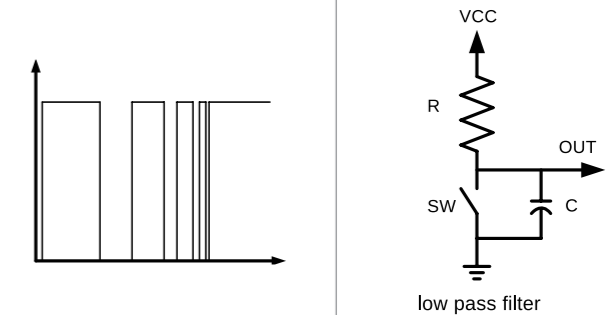

## Swing over Time

This is the time taken by the mobile contact to move from one fixed contact to its rest position against the other fixed contact, including bounce time. The method of actuating, the type of microswitch and the actuator operating speed all affect this value which is generally less than 15 ms.

## Electrical Life

The electrical life expectancy is the number of switching cycles a switch can operate under rated power. Our microswitches are tested under a resistive load.

The electrical life is reduced depending on the nature of the load, i.e. an inductive load (motor). A reduction of the switching power increases the electrical life of the switch.

The electrical life expectancy depends on a number of parameters: applied power, nature of the load, switching frequency, duty cycle, etc. We recommend that you run life tests on your specific application to establish the length of the electrical life with precision in your application.

## Mechanical Life

The number of cycles a switch can achieve without any power applied is the observed mechanical life.

## Contact Resistance

This is the sum of the resistances of the individual components which permit the flow of current when the contacts are closed. It is generally less than 60 milliohms.

In microswitches with a potted cable, the resistance of the cable has to be added.

## Insulation Resistance

This is the resistance between the inside contacts and the external surface of the housing. For a new microswitch, this insulation resistance is superior than 10 MOhm.

## Degree of Protection





The designation to indicate the degree of protection consists of the letters IP followed by two numerals. The first one indicating the protection of the housing against ingress of solid foreign bodies.

The second numeral indicates the protection against harmful intrusion of water as in the table indicated below.

1 <sup>st</sup> numeral	Protection against solid objects	2 <sup>nd</sup> numeral	Protection against water intrusion
0	Without protection	0	Without protection
1	Protection against solid objects > 50 mm	1	Protection against dripping water
2	Protection against solid objects > 12.5mm	2	Protection against dripping water when tilted up to 15°
3	Protection against solid objects > 2.5 mm	3	Protection against spraying water
4	Protection against solid objects > 1 mm	4	Protection against splashing water
5	Dust protected	5	Protection against water jets
6	Dust tight	6	Protection against powerful water jets
		7	Protection against temporary immersion
		8	Protection against continuous immersion

## Approval and Marking

Our microswitches are tested and certified following international norms; the following norms are applied to our products:

UL	UL 61058		CSA	C22.2	
EN	EN 61058		ATEX	EN 60079	

## REACH - RoHS

The products manufactured by Microprecision Electronics SA do not have to be registered or pre-registered under the REACH regulation. We have contacted all our suppliers to confirm that there are no substances of concern in the materials from where we receive them. To the best of our knowledge we do not use any substances in our products and they therefore conform to the REACH and RoHS regulations.

## ISO9001

The norm ISO9001:2008 specifies a quality management system. A company has to show its capability to manufacture in a consistent manner product which fulfill customer requirement as well as legal and regulatory requirement.

On a regular basis, an external auditing body verifies that Microprecision Electronics SA is complying with the requirements of that norm. The actual certification body is AFAQ.



# Installation Recommendations

## Mounting

The microswitches have to be fixed on a smooth, flat surface using the recommended screw size. Do not tighten the screw more than indicated as the switch could be damaged. For increased security use an epoxy resin to glue the microswitch in place.

Do not exceed the recommended tightening torque for the screws:

Screw size	M2	M3	M3.5	M4
Tightening torque in Nm	0.3	0.5	0.8	1.2

## Position and use

For the most reliable function of the microswitch, extend over actuating point by 50% of the available over travel. When releasing the switch and moving back in its free position, make sure there is no pre-loading force applied to ensure stable free position.

The microswitch should not be used as a mechanical stop by fully taking up the over travel. A strong impact on the housing could damage the switch or affect its life span.

## Telescopic Plunger

A telescopic plunger allows to increase the available over travel. Whenever possible the mounting should be done using the threaded collar and tightening the nuts provided for that purpose. The length of the threaded collar can easily be custom modified to adapt to your mounting requirements.

### Domed Plunger

The telescopic plunger has to be pressed axially. The deviation from the plunger axis should not exceed 5°. The plunger can be supplied with a protective sleeve to prevent foreign bodies from penetrating between the actuator button and the collar.

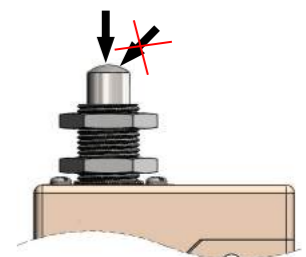

### Roller Plunger

The roller plunger can be actuated by means of a rotating or sliding cam. The strike angle and position must be calculated in such a way to avoid a sudden shock on the roller. The roller plunger must not be struck by a cam with an attack angle exceeding 40° and a speed higher than 2m/s. For a speed up to 3 m/s, the angle has to be lower than 30°.

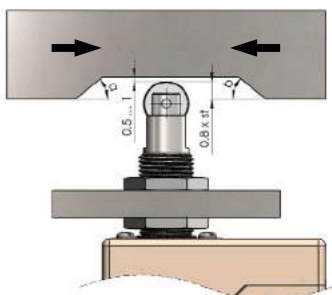

## Indirect Action Levers

### Simple Lever

The straight levers are the most robust and reliable of the lever actuators. The small switch plunger button is protected against sudden impact and an excessive force. In the initial position, the lever is pressing down the plunger button. Activating the lever releases the plunger.

These levers can easily be modified by extending the lever or adding rollers or floaters.

### Indirect Roller Lever

This auxiliary actuator is recommended for rapid movements while sharp striking angles and shocks to the roller should be avoided. The cam must ease the lever back to the initial free position.

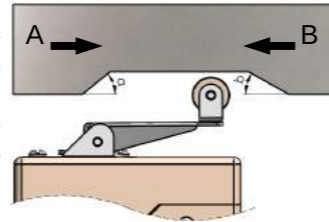

Please observe the following maximum angles for speeds up to 2 m/s.

- Approach from A: max 45°
- Approach from B: max 30°

### Lever with Bending Roller

The actuator is operated only by travel from A. The actuator is not operated on the return travel of a rotating or sliding cam.

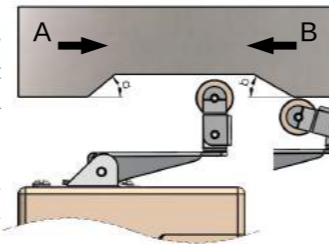

The limitations on the striking angles are the same as for an indirect roller lever, with a limitation on speed of 2 m/s.

- Approach from A: max 45°
- Approach from B: max 30°

**IMPORTANT:** This form of actuator must be very accurately installed in order that the roller stirrup may tip back without forcing or actuating the microswitch. Too low a striking point will cause the stirrup to wrench from the lever.

## Direct Action Levers

The lever acts directly on the pin plunger with an actuating force at the end of the lever arm reduced by its length. The application conditions remain the same as for the indirect levers.

The lever can easily be adapted to your requirements by extending or bending the lever arm or by adding rollers or floaters.



## Soldering

Prevent any overheating of the contacts when soldering. Using excessive heat can displace the contacts and damage the microswitch. Do not apply force to the contacts immediately after soldering.

## Cable Cross Section

The cable cross section has to be adapted to the rated power used as per the table below. If an application is requiring a cross section lower than the section recommended, Microprecision Electronics SA will print on the switch the rated power corresponding to the used cable.

Standard Series	Cross Section (mm <sup>2</sup> )	Power Rating
MP400-500	0.25	250VAC 2A
MP400-500	0.50	250VAC 5A
MP300	0.75	250VAC 6A
MP220-225	1.00	250VAC 10A
MP40-90-110-210-215	1.00	400VAC 10A
MP40-90-110-210	1.50	250VAC 15A

## Cable Exit Option

Depending on your application Microprecision Electronics SA may propose different cable or wires, these options also include the possibility to have them exit the switch on the left, right or below.

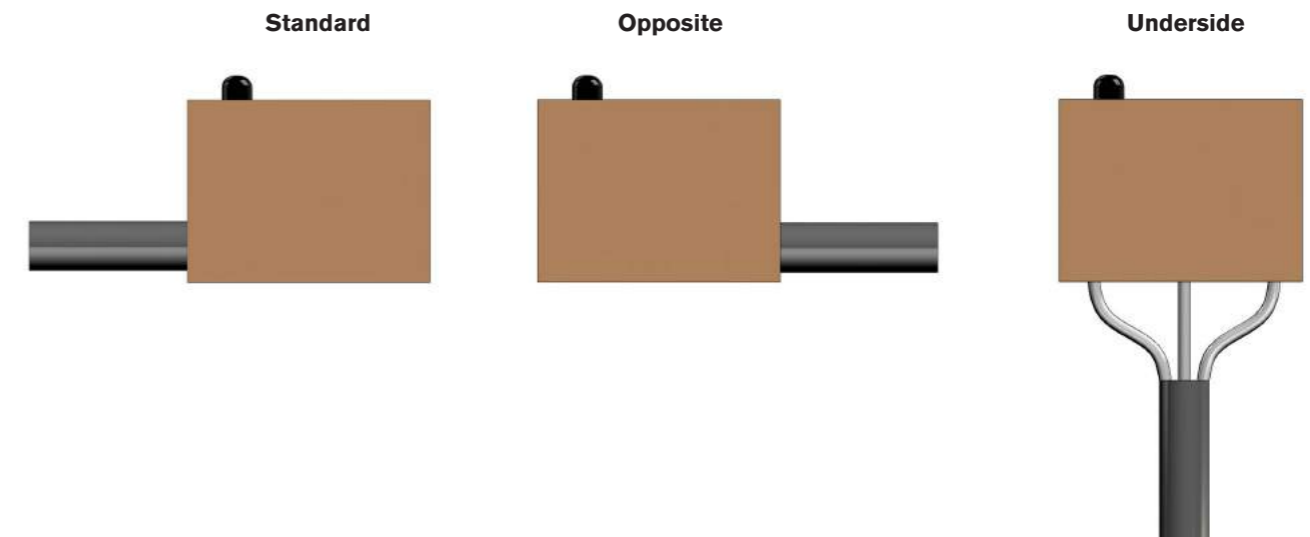

## Cable Material

The cable standard is PVC - Polyvinyl Chloride for normal applications. The temperature range is normally between -20° C and +105°C, and may vary depending on the manufacturer and product.

For special applications other cable materials are also available:

PUR - Polyurethane: Excellent wear-and-tear resistance and resists most oils

SI - Silicone: Ideal for high temperature

See microswitch family for the specific options on the cable. The specifications of a cable may vary.

# Microswitch - SERIES MP40



## MP40

Basic snap action microswitch. A precision microswitch for high breaking capacity, the MP40 series offer IP40 protection with screw lugs or solder terminals using a wide range of interchangeable actuators. The switch is ideally suited for industrial applications with its wide operational temperature range and optional low actuating force.



## Description

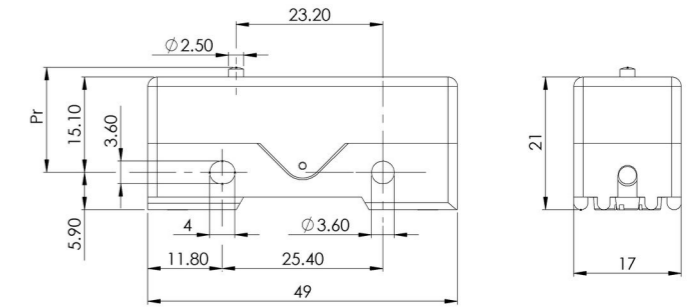
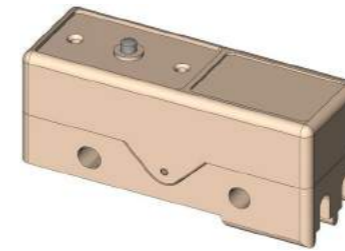

## MP40

<b>Approval</b>	EN 61058-1	250VAC/15A	50'000 cycles
	EN 61058-1	400VAC/10A	50'000 cycles
	UL 61058-1	250VAC/15A	50'000 cycles
	UL 61058-1	400VAC/10A	50'000 cycles
	Resistive load		

<b>Housing</b>	Plastic reinforced with glass fiber (PBT)
<b>Pin Button</b>	PBT
<b>Switching Circuit</b>	Change over - snap action with blade spring in copper/beryllium
<b>Contact</b>	Silver - optional gold
<b>Connection</b>	Screw, solder lugs, protection cover
<b>Actuator</b>	Stainless steel

<b>Degree of Protection</b>	Housing IP40 Connection IP00 Protection Cover IP20
<b>Class of Protection</b>	II
<b>Micro-switching</b>	μ
<b>Distance between Contacts</b>	0.30 mm
<b>Dimensions</b>	DIN 41 635, form A 49 x 21 x 17 mm

<b>Actuation Force</b>	Between 0.2 to 6.0 N, depending on the lever
<b>Differential Travel</b>	0.05 mm - Optional 0.02 mm
<b>Temperature Range</b>	EN 61058-1 -40°C to +130°C UL 61058-1 -40°C to +130°C
<b>Mechanical Life</b>	50 x 10 <sup>6</sup> cycles



# Actuator

Type **0**: Basic switch - Pin Button

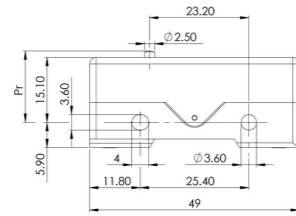
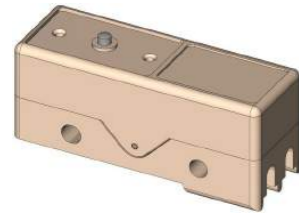

Actuating Force Fa max. (N)	5.0
Release Force Fr min. (N)	2.5
Free Position Pr (mm)	16.3 ± 0.5
Operating Position Pa (mm)	15.9 ± 0.3
Over-Travel sr min. (mm)	0.25
Differential Travel sd max. (mm)	0.05

Type **1S21**: Telescopic Built-In

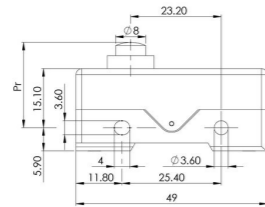
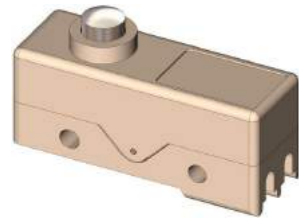

Actuating Force Fa max. (N)	5.0
Release Force Fr min. (N)	2.0
Free Position Pr (mm)	21.7 ± 0.6
Operating Position Pa (mm)	21.3 ± 0.3
Over-Travel sr min. (mm)	1.2
Differential Travel sd max. (mm)	0.06

Type **1SP21**: Telescopic Built-In with Protective Sleeve

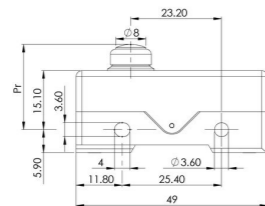
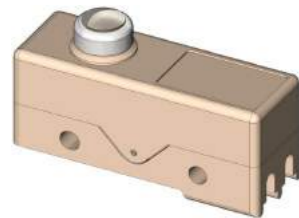

Actuating Force Fa max. (N)	5.0
Release Force Fr min. (N)	2.0
Free Position Pr (mm)	21.7 ± 0.6
Operating Position Pa (mm)	21.3 ± 0.3
Over-Travel sr min. (mm)	1.00
Differential Travel sd max. (mm)	0.06

Type **1S29**: Telescopic

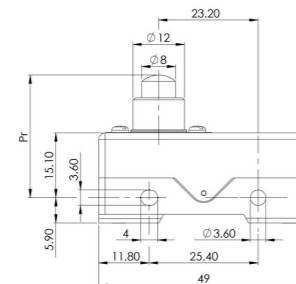
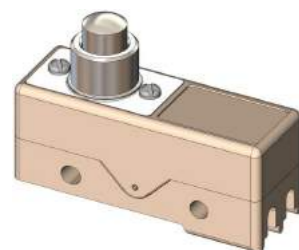

Actuating Force Fa max. (N)	5.0
Release Force Fr min. (N)	2.5
Free Position Pr (mm)	28.4 ± 0.6
Operating Position Pa (mm)	27.9 ± 0.3
Over-Travel sr min. (mm)	2.0
Differential Travel sd max. (mm)	0.05

# Actuator

Type **1A**: Telescopic with Short Thread

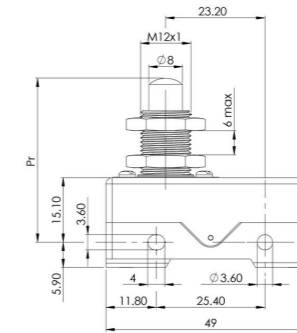
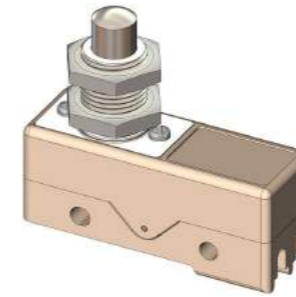

Actuating Force Fa max. (N)	5.0
Release Force Fr min. (N)	2.5
Free Position Pr (mm)	38.0 ± 0.6
Operating Position Pa (mm)	37.5 ± 0.3
Over-Travel sr min. (mm)	5.0
Differential Travel sd max. (mm)	0.05

Type **1A58**: Telescopic with Thread

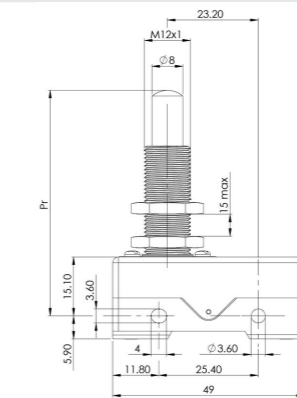
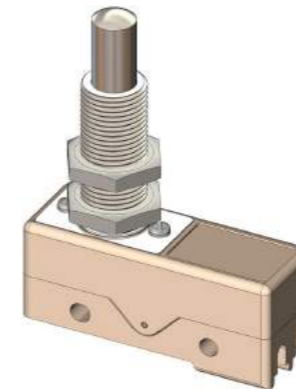

Actuating Force Fa max. (N)	5.0
Release Force Fr min. (N)	2.5
Free Position Pr (mm)	57.2 ± 1.0
Operating Position Pa (mm)	56.7 ± 0.3
Over-Travel sr min. (mm)	10.0
Differential Travel sd max. (mm)	0.10

Type **1BL**: Telescopic with Roller

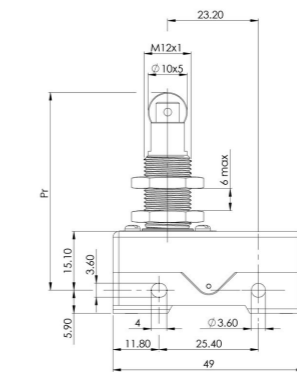
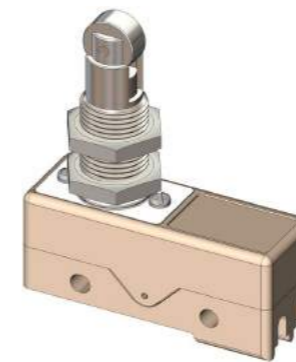

Actuating Force Fa max. (N)	5.0
Release Force Fr min. (N)	2.5
Free Position Pr (mm)	50.3 ± 0.6
Operating Position Pa (mm)	49.8 ± 0.3
Over-Travel sr min. (mm)	5.0
Differential Travel sd max. (mm)	0.05

Optional: stainless steel roller, transvers roller

Type **2A**: Simple Lever - Direct Action -

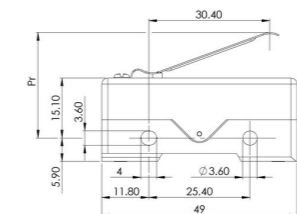
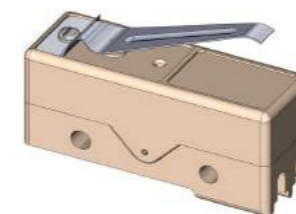

Actuating Force Fa max. (N)	2.5
Release Force Fr min. (N)	0.7
Free Position Pr (mm)	27.0 ± 2.0
Operating Position Pa (mm)	22.0 ± 2.0
Over-Travel sr min. (mm)	2.0
Differential Travel sd max. (mm)	0.80

# Actuator

Type **3A** : Simple Lever - Indirect Action -

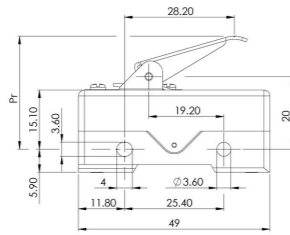
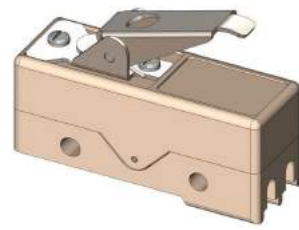

Actuating Force Fa max. (N)	4.5
Release Force Fr min. (N)	1.5
Free Position Pr (mm)	28.7 ± 1.5
Operating Position Pa (mm)	26.8 ± 1.5
Over-Travel sr min. (mm)	3.5
Differential Travel sd max. (mm)	0.50

Optional : lever mounted on opposite side

Type **4AL** : Simple Lever with Roller - Direct Action -

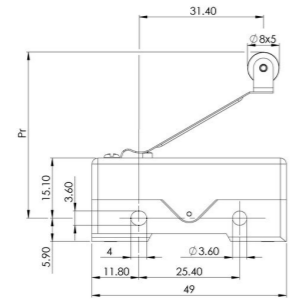
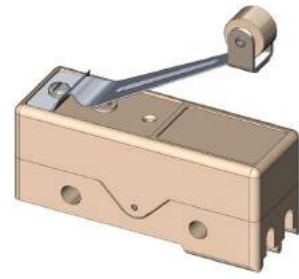

Actuating Force Fa max. (N)	2.5
Release Force Fr min. (N)	0.7
Free Position Pr (mm)	40.0 ± 2.0
Operating Position Pa (mm)	34.0 ± 2.0
Over-Travel sr min. (mm)	2.0
Differential Travel sd max. (mm)	0.80

Type **5AL** : Simple Lever with Roller - Indirect Action -

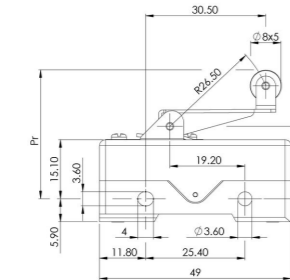
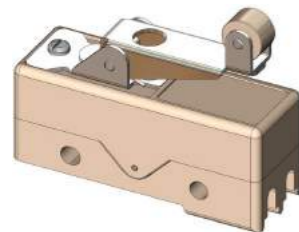

Actuating Force Fa max. (N)	4.5
Release Force Fr min. (N)	1.5
Free Position Pr (mm)	32.4 ± 1.5
Operating Position Pa (mm)	30.0 ± 1.5
Over-Travel sr min. (mm)	3.5
Differential Travel sd max. (mm)	0.50

Optional : lever mounted on opposite side, stainless steel roller, transvers roller

Type **6AL** : Simple Lever with Bending Roller - Indirect Action -

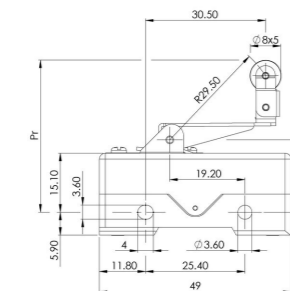
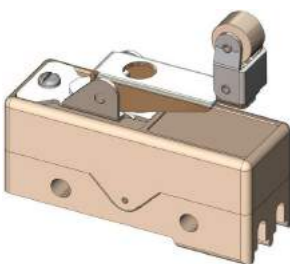

Actuating Force Fa max. (N)	4.5
Release Force Fr min. (N)	1.5
Free Position Pr (mm)	38.4 ± 1.5
Operating Position Pa (mm)	36.0 ± 1.5
Over-Travel sr min. (mm)	3.5
Differential Travel sd max. (mm)	0.50

Optional : lever mounted on opposite side, stainless steel roller, transvers roller

# Actuator

Type **7A40** : Simple Adjustable Lever - Direct Action -

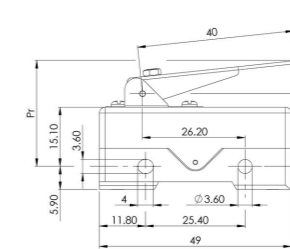
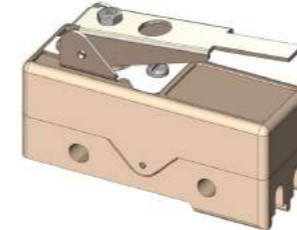

Actuating Force Fa max. (N)	0.5
Release Force Fr min. (N)	0.15
Free Position Pr (mm)	-
Operating Position Pa (mm)	Ajustable
Over-Travel sr min. (mm)	-
Differential Travel sd max. (mm)	0.70

Optional : lever mounted on opposite side

Type **7AC** : Simple Adjustable Lever with Wire - Direct Action -

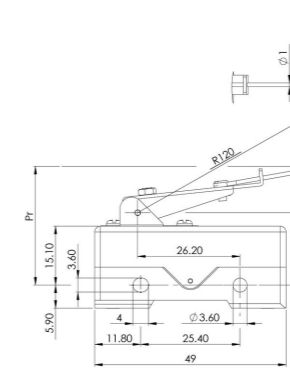

Actuating Force Fa max. (N)	0.2
Release Force Fr min. (N)	0.05
Free Position Pr (mm)	-
Operating Position Pa (mm)	Ajustable
Over-Travel sr min. (mm)	-
Differential Travel sd max. (mm)	3.00

Optional : lever mounted on opposite side

Type **8AL40** : Simple Adjustable Lever with Roller - Direct Action -

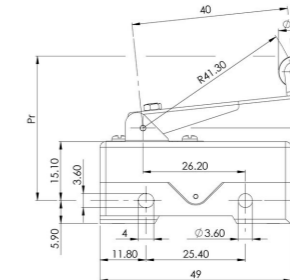
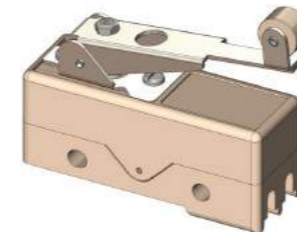

Actuating Force Fa max. (N)	0.5
Release Force Fr min. (N)	0.15
Free Position Pr (mm)	-
Operating Position Pa (mm)	Ajustable
Over-Travel sr min. (mm)	-
Differential Travel sd max. (mm)	0.70

Optional : lever mounted opposite side, stainless steel roller, transvers roller

## Electrical Circuit

	Actuator Code	Circuit		Actuator Code	Circuit
Direct Action	0		Indirect Action	3A	
	1S21			5AL	
	1SP21			6AL	
	1S29				
	1A				
	1A58				
	1BL				
	2A				
	4AL				
	7A40				
	7AC				
	8AL40				

## Protection Cover

A protection cover is available to protect the user from any contact with the terminals of the MP40 under power. The protection cover MP40-Z is fixed to the MP40 housing by means of a screw Parker.

### MP40-0 + MP40-Z

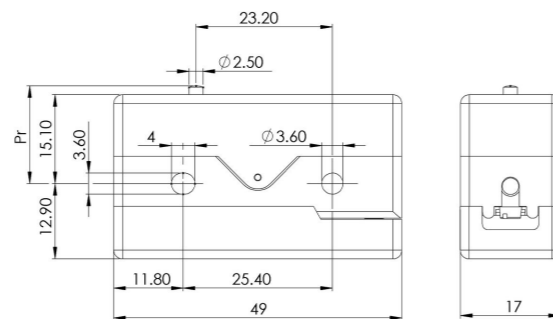
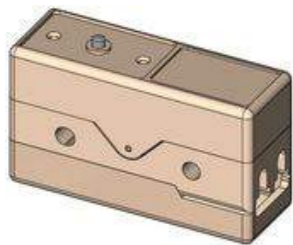

## Ordering Information

	MP	4	0	-	5AL	+	MP40-Z
<b>Housing</b>							
4:	Screw Terminals						
5:	Solder Lugs						
<b>Contact</b>							
0:	Silver Contact						
1:	Gold Contact						
<b>Actuator</b>							
0:	Basic switch - Pin Button						
1S21	Telescopic Built-In						
1SP21	Telescopic Built-In with Protective Sleeve						
1S29:	Telescopic						
1A:	Telescopic with Short Thread						
1A58:	Telescopic with Thread						
1BL:	Telescopic with Roller						
2A:	Simple Lever - Direct Action						
3A:	Simple Lever - Indirect Action						
4AL:	Simple Lever with Roller - Direct Action						
5AL:	Simple Lever with Roller - Indirect Action						
6AL:	Simple Lever with Bending Roller - Indirect Action						
7A40:	Simple Adjustable Lever - Direct Action						
7AC:	Simple Adjustable Lever with Wire – Direct Action						
8AL40:	Simple Adjustable Lever with Roller - Direct Action						
<b>Optional</b>							
MP40-Z	Protection Cover						

# Microswitch - SERIES MP90

Series MP90



## MP90

Sealed basic snap action microswitch. A precision microswitch for high breaking capacity, the MP90 series offers IP67 protection using a wide range of interchangeable actuators.

The housing is IP67 sealed using an ultrasonic welding process. High operating temperature and long life makes this switch a perfect solution for industrial applications



## Description

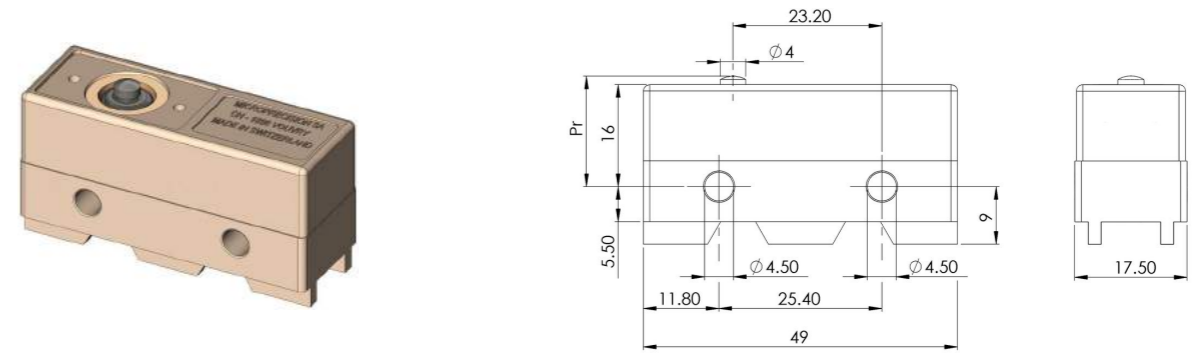

## MP90

<b>Approval</b>	EN 61058-1 250VAC/15A 50'000 cycles EN 61058-1 400VAC/10A 50'000 cycles UL 61058-1 250VAC/15A 50'000 cycles UL 61058-1 400VAC/10A 50'000 cycles Resistive load
<b>Housing</b>	Plastic reinforced with glass fiber (PBT)
<b>Pin Button</b>	PC
<b>Membrane</b>	Fluorosilicone - other optional materials available
<b>Switching Circuit</b>	Change over - snap action with blade spring in copper/beryllium
<b>Contact</b>	Silver - optional gold
<b>Connection</b>	Screw
<b>Actuator</b>	Stainless steel
<b>Degree of Protection</b>	Housing IP67 Connection IP00
<b>Class of Protection</b>	II
<b>Micro-switching</b>	μ
<b>Distance between Contacts</b>	0.50 mm
<b>Dimensions</b>	DIN 41 635, form ES 49 x 25 x 17.5 mm
<b>Actuation Force</b>	Between 0.2 to 6.0 N, depending on the lever
<b>Differential Travel</b>	0.05 mm - Optional 0.02 mm
<b>Temperature Range</b>	EN 61058-1 -40°C to +130°C UL 61058-1 -40°C to +125°C
<b>Mechanical Life</b>	50 x 10 <sup>6</sup> cycles

Series MP90

# Actuator

Type 0: Basic switch - Pin Button

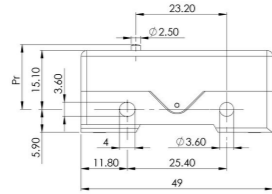

Actuating Force Fa max. (N)	6.0
Release Force Fr min. (N)	3.0
Free Position Pr (mm)	17.4 ± 0.5
Operating Position Pa (mm)	16.7 ± 0.3
Over-Travel sr min. (mm)	0.25
Differential Travel sd max. (mm)	0.06

Type 1S29: Telescopic

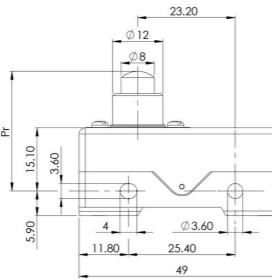
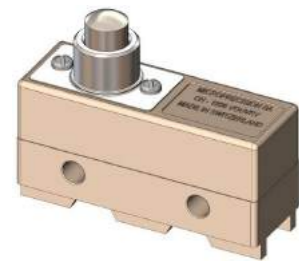

Actuating Force Fa max. (N)	6.0
Release Force Fr min. (N)	3.0
Free Position Pr (mm)	29.3 ± 0.6
Operating Position Pa (mm)	28.5 ± 0.3
Over-Travel sr min. (mm)	2.0
Differential Travel sd max. (mm)	0.08

Type 1A: Telescopic with Short Thread

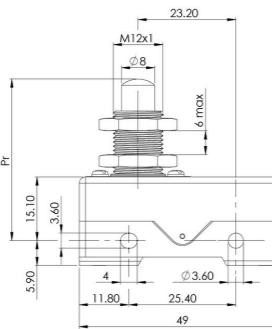
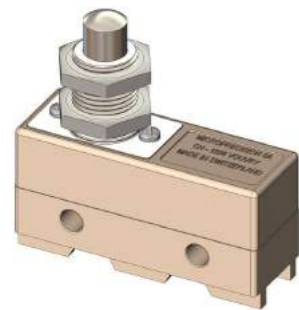

Actuating Force Fa max. (N)	6.0
Release Force Fr min. (N)	3.0
Free Position Pr (mm)	39.1 ± 0.6
Operating Position Pa (mm)	38.4 ± 0.3
Over-Travel sr min. (mm)	5.0
Differential Travel sd max. (mm)	0.08

Type 1A58: Telescopic with Thread

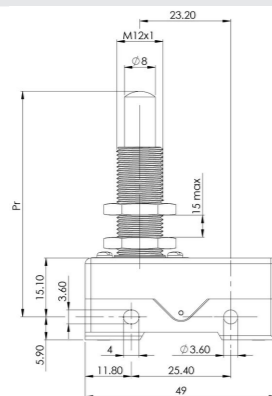
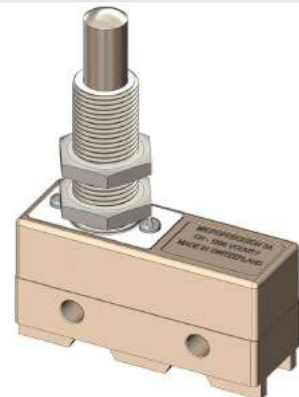

Actuating Force Fa max. (N)	6.0
Release Force Fr min. (N)	2.5
Free Position Pr (mm)	58.0 ± 1.0
Operating Position Pa (mm)	57.3 ± 0.3
Over-Travel sr min. (mm)	10.0
Differential Travel sd max. (mm)	0.10

# Actuator

Type 1BL: Telescopic with Roller

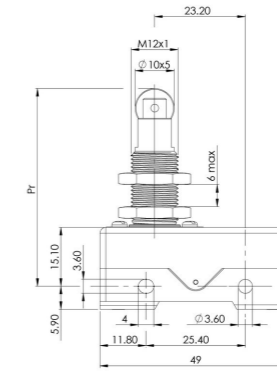
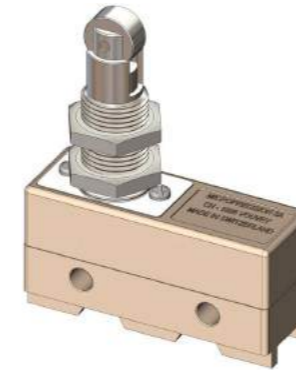

Actuating Force Fa max. (N)	6.0
Release Force Fr min. (N)	3.0
Free Position Pr (mm)	51.3 ± 0.6
Operating Position Pa (mm)	50.6 ± 0.3
Over-Travel sr min. (mm)	5.0
Differential Travel sd max. (mm)	0.08

Optional: stainless steel roller, transvers roller

Type 3A: Simple Lever - Indirect Action -

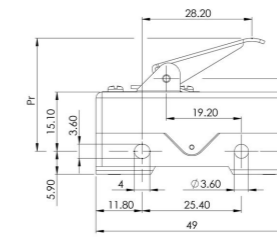
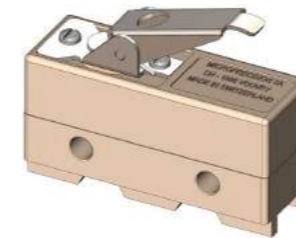

Actuating Force Fa max. (N)	4.5
Release Force Fr min. (N)	1.2
Free Position Pr (mm)	30.3 ± 1.5
Operating Position Pa (mm)	28.5 ± 1.5
Over-Travel sr min. (mm)	3.5
Differential Travel sd max. (mm)	0.50

Optional: lever mounted on opposite side

Type 5AL: Simple Lever with Roller - Indirect Action -

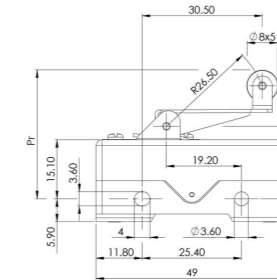
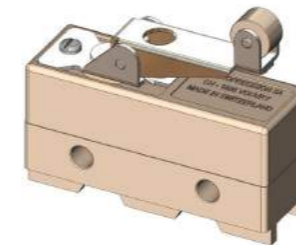

Actuating Force Fa max. (N)	4.5
Release Force Fr min. (N)	1.2
Free Position Pr (mm)	34.4 ± 1.5
Operating Position Pa (mm)	31.9 ± 1.5
Over-Travel sr min. (mm)	3.5
Differential Travel sd max. (mm)	0.60

Optional: lever mounted on opposite side, stainless steel roller, transvers roller

Type 6AL: Simple Lever with Bending Roller - Indirect Action -

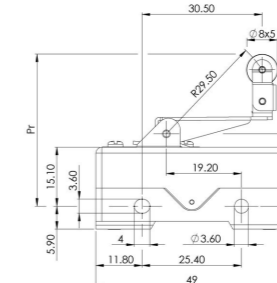
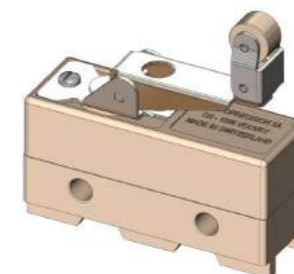

Actuating Force Fa max. (N)	4.5
Release Force Fr min. (N)	1.2
Free Position Pr (mm)	40.5 ± 1.5
Operating Position Pa (mm)	37.9 ± 1.5
Over-Travel sr min. (mm)	3.5
Differential Travel sd max. (mm)	0.60

Optional: lever mounted on opposite side, stainless steel roller, transvers roller

## Actuator

### Type 7A40: Simple Adjustable Lever - Direct Action -

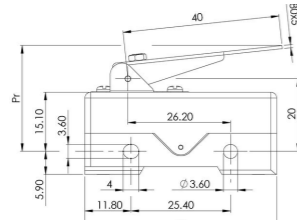

Actuating Force Fa max. (N)	0.6
Release Force Fr min. (N)	0.2
Free Position Pr (mm)	-
Operating Position Pa (mm)	Ajustable
Over-Travel sr min. (mm)	-
Differential Travel sd max. (mm)	0.80

Optional: lever mounted on opposite side

### Type 7AC: Simple Adjustable Lever with Wire - Direct Action -

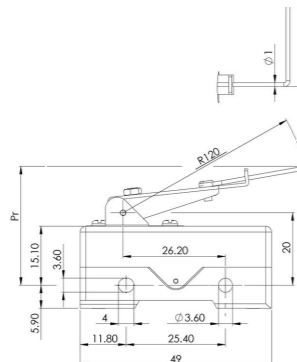

Actuating Force Fa max. (N)	0.2
Release Force Fr min. (N)	0.05
Free Position Pr (mm)	-
Operating Position Pa (mm)	Ajustable
Over-Travel sr min. (mm)	-
Differential Travel sd max. (mm)	4.00

Optional: lever mounted on opposite side

### Type 7AF/63.5/50: Simple Lever with Floater - Direct Action -

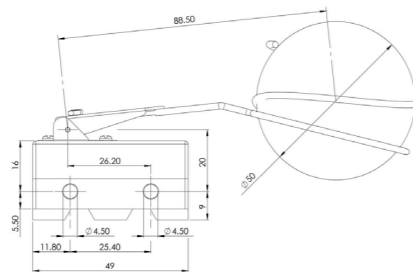

Actuating Force Fa max. (N)	-
Release Force Fr min. (N)	-
Free Position Pr (mm)	-
Operating Position Pa (mm)	Ajustable
Over-Travel sr min. (mm)	-
Differential Travel sd max. (mm)	2.00

Optional: lever mounted on opposite side

### Type 8AL40: Simple Adjustable Lever with Roller - Direct Action -

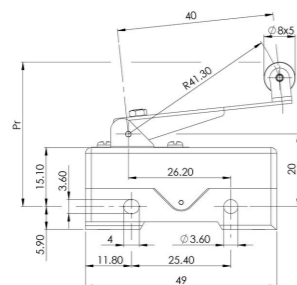

Actuating Force Fa max. (N)	0.6
Release Force Fr min. (N)	0.2
Free Position Pr (mm)	-
Operating Position Pa (mm)	Ajustable
Over-Travel sr min. (mm)	-
Differential Travel sd max. (mm)	0.80

Optional: lever mounted opposite side, stainless steel roller, transvers roller

## Electrical Circuit

	Actuator Code	Circuit		Actuator Code	Circuit
Direct Action	0		Indirect Action	3A	
	1S29			5AL	
	1A			6AL	
	1A58				
	1BL				
	7A40				
	7AC				
	7AF/63.5/50				
	8AL40				

## Ordering Information

MP9 0 - 5AL

### Contact

0:	Silver Contact
1:	Gold Contact

### Actuator

0:	Basic switch - Pin Button
1S29:	Telescopic
1A:	Telescopic with Short Thread
1A58:	Telescopic with Thread
1BL:	Telescopic with Roller
3A:	Simple Lever - Indirect Action
5AL:	Simple Lever with Roller - Indirect Action
6AL:	Simple Lever with Bending Roller - Indirect Action
7A40:	Simple Adjustable Lever - Direct Action
7AC:	Simple Adjustable Lever with Wire - Direct Action
7AF/63.5/50:	Simple Lever with Floater - Direct Action
8AL40:	Simple Adjustable Lever with Roller - Direct Action

# Microswitch - SERIES MP110



## MP110

Sealed basic snap action microswitch. A precision microswitch for high breaking capacity, the MP110 series offers IP67 protection using a wide range of interchangeable actuators.

The housing is IP67 sealed using an ultrasonic welding process. AMP style solder lugs allow the use of an additional plug in socket for a complete IP67 cable solution.

A protective terminal cover with field wiring kit allows IP64 protection.

The right microswitch for industrial use when IP67 protection is needed. Changing the switch without changing the wire connection is a big plus for this switch.

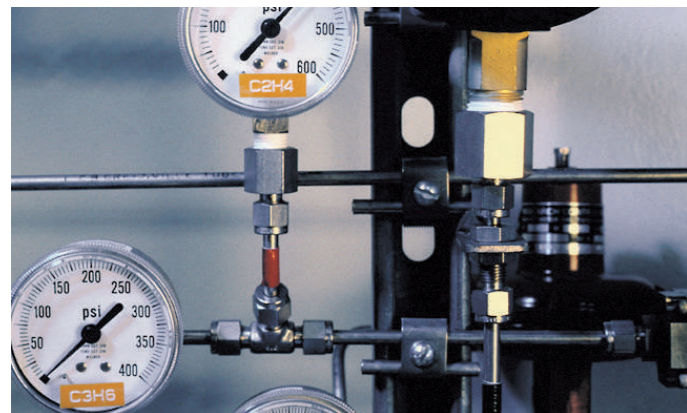

## Description

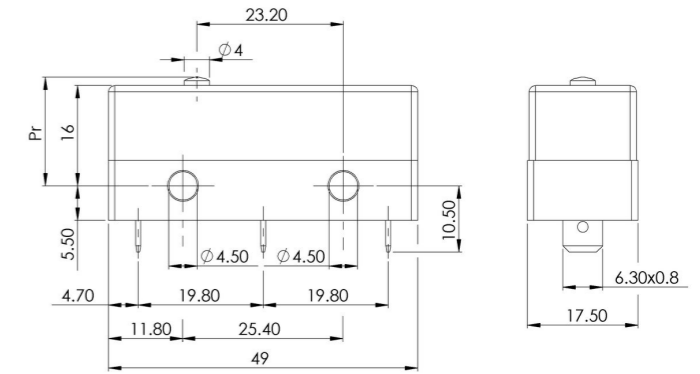

## MP110

<b>Approval</b>	EN 61058-1	250VAC/15A	50'000 cycles
	EN 61058-1	400VAC/10A	50'000 cycles
	UL 61058-1	250VAC/15A	50'000 cycles
	UL 61058-1	400VAC/10A	50'000 cycles
	Resistive load		

<b>Housing</b>	Plastic reinforced with glass fiber (PBT)
<b>Pin Button</b>	PC
<b>Membrane</b>	Fluorosilicone - other optional materials available
<b>Switching Circuit</b>	Change over - snap action with blade spring in copper/beryllium
<b>Contact</b>	Silver - optional gold
<b>Connection</b>	AMP solder lugs 6.35x0.80 mm, plug-in socket, protection cover
<b>Actuator</b>	Stainless steel
<b>Degree of Protection</b>	Housing IP67 Connection IP00 Protection Cover IP64 Plug-in IP67
<b>Class of Protection</b>	II
<b>Micro-switching</b>	μ
<b>Distance between Contacts</b>	0.50 mm
<b>Dimensions</b>	DIN 41 635, form EF 49 x 21.5 x 17.5 mm
<b>Actuation Force</b>	Between 0.2 to 6.0 N, depending on the lever
<b>Differential Travel</b>	0.05 mm - Optional 0.02 mm
<b>Temperature Range</b>	EN 61058-1 -40°C to +130°C UL 61058-1 -40°C to +125°C
<b>Mechanical Life</b>	50 x 10 <sup>6</sup> cycles

## Actuator

Type 0: Basic switch - Pin Button

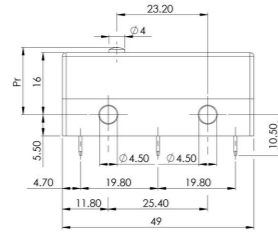

Actuating Force Fa max. (N)	6.0
Release Force Fr min. (N)	3.0
Free Position Pr (mm)	17.4 ± 0.5
Operating Position Pa (mm)	16.6 ± 0.3
Over-Travel sr min. (mm)	0.25
Differential Travel sd max. (mm)	0.06

Type 1S29: Telescopic

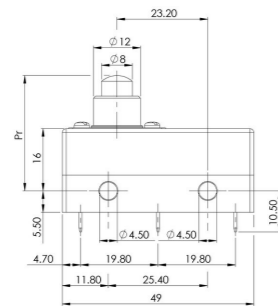

Actuating Force Fa max. (N)	6.0
Release Force Fr min. (N)	3.0
Free Position Pr (mm)	29.3 ± 0.6
Operating Position Pa (mm)	28.5 ± 0.3
Over-Travel sr min. (mm)	2.0
Differential Travel sd max. (mm)	0.08

Type 1A: Telescopic with Short Thread

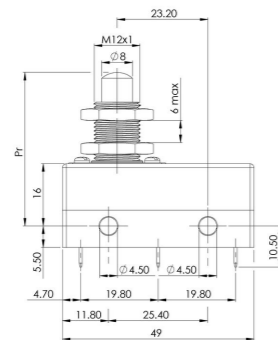
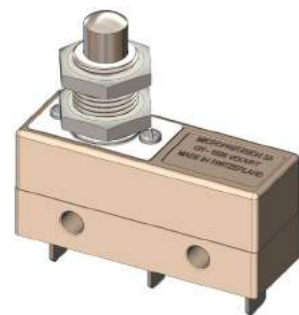

Actuating Force Fa max. (N)	6.0
Release Force Fr min. (N)	3.0
Free Position Pr (mm)	39.1 ± 0.6
Operating Position Pa (mm)	38.4 ± 0.3
Over-Travel sr min. (mm)	5.0
Differential Travel sd max. (mm)	0.08

Type 1A58: Telescopic with Thread

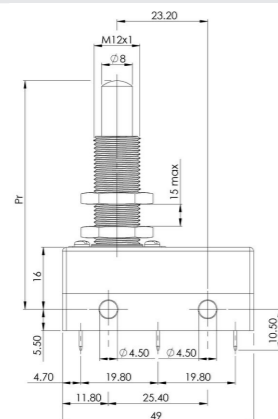
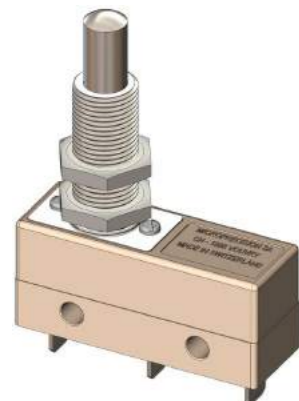

Actuating Force Fa max. (N)	6.0
Release Force Fr min. (N)	2.5
Free Position Pr (mm)	58.0 ± 1.0
Operating Position Pa (mm)	57.3 ± 0.3
Over-Travel sr min. (mm)	10.0
Differential Travel sd max. (mm)	0.10

## Actuator

Type 1BL: Telescopic with Roller

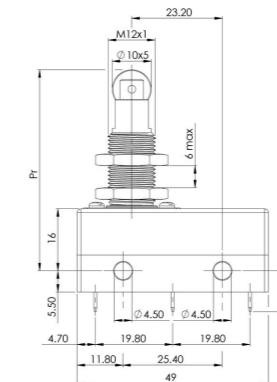
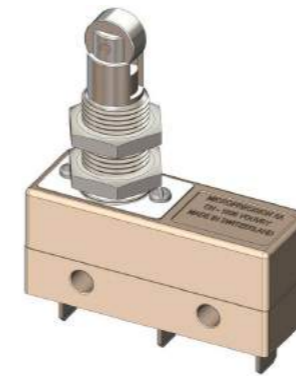

Actuating Force Fa max. (N)	6.0
Release Force Fr min. (N)	3.0
Free Position Pr (mm)	51.3 ± 0.6
Operating Position Pa (mm)	50.6 ± 0.3
Over-Travel sr min. (mm)	5.0
Differential Travel sd max. (mm)	0.08

Optional: stainless steel roller, transvers roller

Type 2A: Simple Lever - Direct Action -

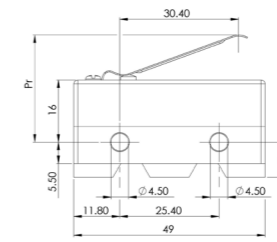

Actuating Force Fa max. (N)	3.5
Release Force Fr min. (N)	1.0
Free Position Pr (mm)	26.0 ± 2.0
Operating Position Pa (mm)	19.0 ± 2.0
Over-Travel sr min. (mm)	2.0
Differential Travel sd max. (mm)	0.80

Type 3A: Simple Lever - Indirect Action -

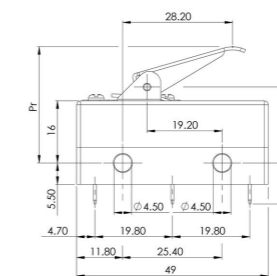

Actuating Force Fa max. (N)	4.5
Release Force Fr min. (N)	1.2
Free Position Pr (mm)	31.3 ± 1.5
Operating Position Pa (mm)	29.3 ± 1.5
Over-Travel sr min. (mm)	3.5
Differential Travel sd max. (mm)	0.50

Optional: lever mounted on opposite side

Type 3AS: Simple lever - Indirect Action -

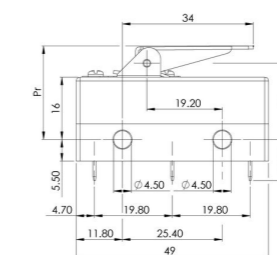
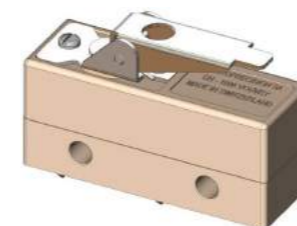

Actuating Force Fa max. (N)	4.7
Release Force Fr min. (N)	1.2
Free Position Pr (mm)	26.0 ± 1.5
Operating Position Pa (mm)	23.0 ± 1.5
Over-Travel sr min. (mm)	3.5
Differential Travel sd max. (mm)	0.60

Optional: lever mounted on opposite side



## Actuator

Type **4AL**: Simple Lever with Roller - **Direct Action** -

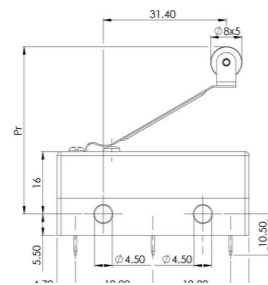

Actuating Force Fa max. (N)	3.5
Release Force Fr min. (N)	1.0
Free Position Pr (mm)	39.0 ± 2.0
Operating Position Pa (mm)	31.0 ± 2.0
Over-Travel sr min. (mm)	2.0
Differential Travel sd max. (mm)	0.80

Type **5AL**: Simple Lever with Roller - **Indirect Action** -

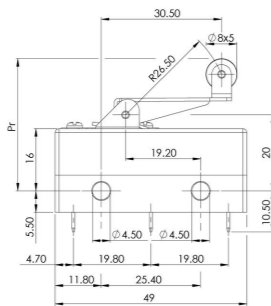
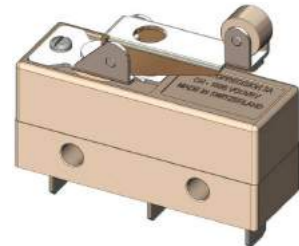

Actuating Force Fa max. (N)	4.5
Release Force Fr min. (N)	1.2
Free Position Pr (mm)	35.8 ± 1.5
Operating Position Pa (mm)	33.0 ± 1.5
Over-Travel sr min. (mm)	3.5
Differential Travel sd max. (mm)	0.60

Optional: lever mounted on opposite side, stainless steel roller, transvers roller

Type **6AL**: Simple Lever with Bending Roller - **Indirect Action** -

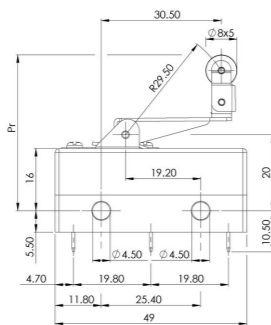
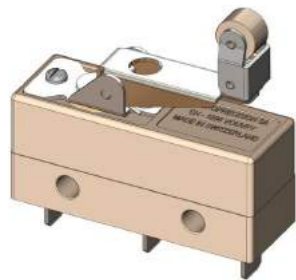

Actuating Force Fa max. (N)	4.5
Release Force Fr min. (N)	1.2
Free Position Pr (mm)	41.9 ± 1.5
Operating Position Pa (mm)	39.0 ± 1.5
Over-Travel sr min. (mm)	3.5
Differential Travel sd max. (mm)	0.60

Optional: lever mounted on opposite side, stainless steel roller, transvers roller

Type **7A40**: Simple Adjustable Lever - **Direct Action** -

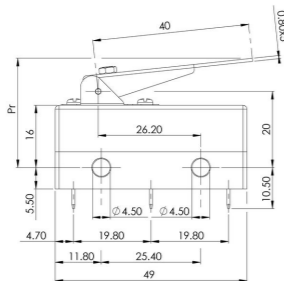

Actuating Force Fa max. (N)	0.6
Release Force Fr min. (N)	0.2
Free Position Pr (mm)	-
Operating Position Pa (mm)	Ajustable
Over-Travel sr min. (mm)	-
Differential Travel sd max. (mm)	0.80

Optional: lever mounted on opposite side

## Actuator

Type **7A120**: Simple Long Adjustable Lever - **Direct Action** -

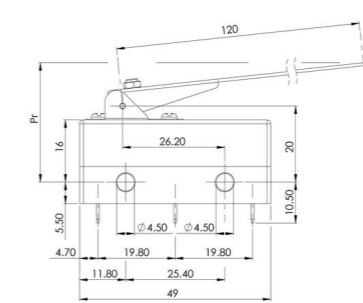

Actuating Force Fa max. (N)	0.2
Release Force Fr min. (N)	0.05
Free Position Pr (mm)	-
Operating Position Pa (mm)	Ajustable
Over-Travel sr min. (mm)	-
Differential Travel sd max. (mm)	3.00

Optional: lever mounted on opposite side

Type **7AC**: Simple Lever with Adjustable Wire - **Direct Action** -

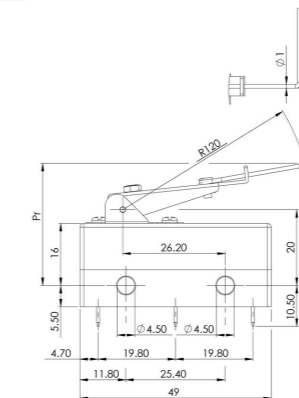

Actuating Force Fa max. (N)	0.2
Release Force Fr min. (N)	0.05
Free Position Pr (mm)	-
Operating Position Pa (mm)	Ajustable
Over-Travel sr min. (mm)	-
Differential Travel sd max. (mm)	4.00

Optional: lever mounted on opposite side

Type **7AF/63.5/50**: Simple Lever with Floater - **Direct Action** -

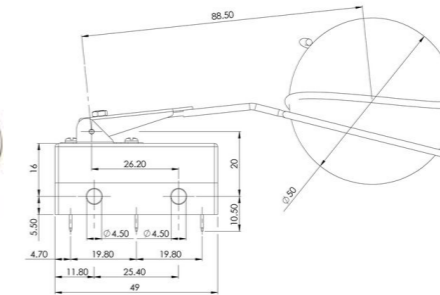

Actuating Force Fa max. (N)	-
Release Force Fr min. (N)	-
Free Position Pr (mm)	-
Operating Position Pa (mm)	Ajustable
Over-Travel sr min. (mm)	-
Differential Travel sd max. (mm)	2.00

Optional: lever mounted on opposite side

Type **8AL40**: Simple Adjustable Lever with Roller - **Direct Action** -

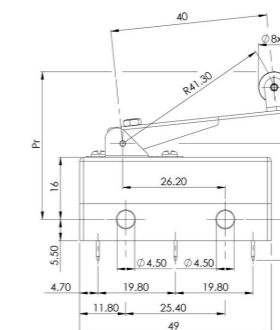

Actuating Force Fa max. (N)	0.6
Release Force Fr min. (N)	0.2
Free Position Pr (mm)	-
Operating Position Pa (mm)	Ajustable
Over-Travel sr min. (mm)	-
Differential Travel sd max. (mm)	0.80

Optional: lever mounted opposite side, stainless steel roller, transvers roller

## Electrical Circuit

	Actuator Code	Circuit		Actuator Code	Circuit
Direct Action	0		Indirect Action	3A	
	1S29			3AS	
	1A			5AL	
	1A58			6AL	
	1BL				
	2A				
	4AL				
	7A40				
	7A120				
	7AC				
7AF/63.5/50					
8AL40					

## Protection Cover MP110-Z

The protective cover MP110-Z(1) with its cable gland PG7(4) guarantees the contacts a degree of protection. A sealing gasket(2) is compressed by tightening the fixing screw M3(3).

There are 3 possible cable outlets, A,B or C. The electrical connection is made with 3 clips 6.35 x 0.8 mm(5) which are crimped to the cable by the end-user.

**MP110-Z**  
Protection Cover IP64

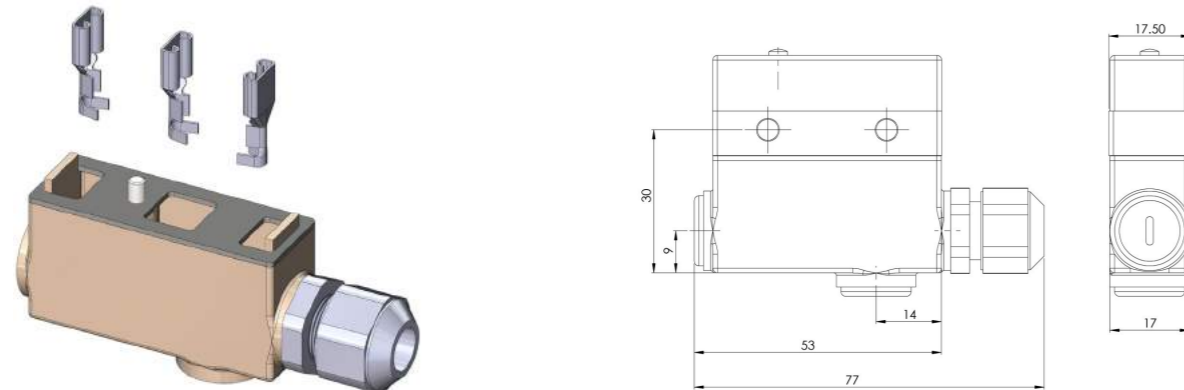

**MP110-Z**  
Protective Cover IP64 - wired

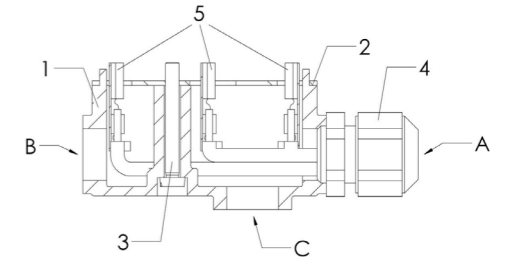
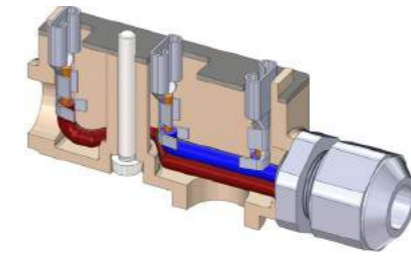

## Plug-in protection MP100-../..

The plug-in socket MP100 with its sealing gasket (1) guarantees a contact protection IP67. The mounting and tightening is made with a screw M3 (2) housed in the socket. The socket is supplied with a cable of your choice directly soldered and potted into the housing.

**MP100-../..**  
Plug-in protection IP67

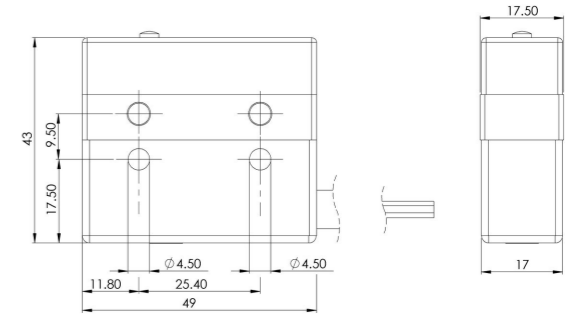
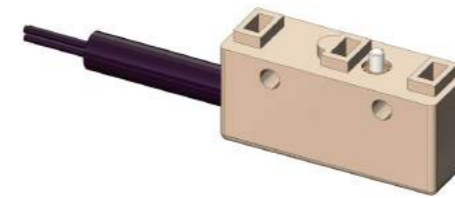

**MP100-../..**  
Plug-in protection IP67 - fixation

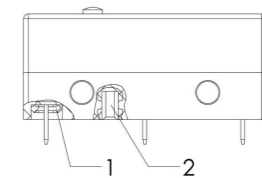
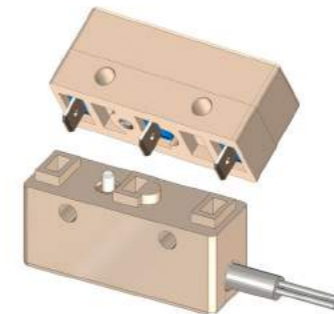

## Cable Options

### MP100-K(L)/10

Polyvinyl Chloride Cable 3 x 1 mm<sup>2</sup> -20°C to +105°C 400VAC 10A

### MP100-K(L)/15

Polyvinyl Chloride Cable 3 x 1.5 mm<sup>2</sup> -20°C to +105°C 250VAC 15A

### MP100-SI(L)/10

Silicone Cable 3 x 1 mm<sup>2</sup> -40°C to +130°C 400VAC 10A

### MP100-SI(L)/15

Silicone Cable 3 x 1.5 mm<sup>2</sup> -40°C to +130°C 250VAC 15A

### MP100-PUR(L)/10

Polyurethane Cable 3 x 1 mm<sup>2</sup> -40°C to +90°C 400VAC 10A

### MP100-PUR(L)/15

Polyurethane Cable 3 x 1.5 mm<sup>2</sup> -40°C to +90°C 250VAC 15A

**L:** Length of the cable in meters(m)

## Color code of wires

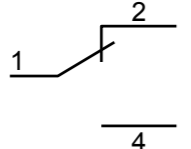
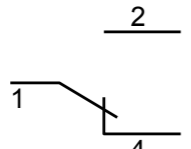
	Actuator Code	Circuit	Color
Direct Action	0		MP100-K: 1 / Brown - 2 / Black - 4 / Blue
	1S29		
	1A		
	1A58		
	1BL		
	2A		
	4AL		
	7A40		
	7A120		
	7AC		
7AF/63.5/50			
8AL40			
Indirect Action	3A		MP100-K: 1 / Brown - 2 / Black - 4 / Blue
	3AS		MP100-SI: 1 / Red - 2 / White - 4 / Blue
	5AL		MP100-PUR: 1 / Red - 2 / White - 4 / Blue
	6AL		MP100-PUR: 1 / Red - 2 / White - 4 / Blue

## Ordering Information

		MP11	0	-	5AL	+	MP100-K2/10
<b>Contact</b>							
<b>0:</b>	Silver Contact						
<b>1:</b>	Gold Contact						
<b>Actuator</b>							
<b>0:</b>	Basic switch - Pin Button						
<b>1S29:</b>	Telescopic						
<b>1A:</b>	Telescopic with Short Thread						
<b>1A58:</b>	Telescopic with Thread						
<b>1BL:</b>	Telescopic with Roller						
<b>2A:</b>	Simple Lever - Direct Action						
<b>3A:</b>	Simple Lever - Indirect Action						
<b>3AS:</b>	Simple Lever - Indirect Action						
<b>4AL:</b>	Simple Lever with Roller - Direct Action						
<b>5AL:</b>	Simple Lever with Roller - Indirect Action						
<b>6AL:</b>	Simple Lever with Bending Roller - Indirect Action						
<b>7A40:</b>	Simple Adjustable Lever - Direct Action						
<b>7A120:</b>	Simple Adjustable Lever - Direct Action						
<b>7AC:</b>	Simple Adjustable Lever with Wire – Direct Action						
<b>7AF /63.5/50:</b>	Simple Lever with Floater - Direct Action						
<b>8AL40:</b>	Simple Adjustable Lever with Roller - Direct Action						
<b>Optional</b>							
<b>MP110-Z</b>	Protection Cover IP64						
<b>MP100-K../..</b>	Plug-in Polyvinyl Chloride Cable L(m), optional 10 or 15A						
<b>MP100-SI../..</b>	Plug-in Silicone Cable L(m), optional 10 or 15A						
<b>MP100-PUR../..</b>	Plug-in Polyurethane Cable L(m), optional 10 or 15A						

# Microswitch - SERIES MP210/220



## MP210/220

The MP210/220 is an IP67 sealed snap action microswitch with potted cable for demanding industrial applications. All actuators are stainless steel for maximum protection in hazardous industrial environments.

The switch can be supplied with two different electrical circuits.

The MP210 version is a single pole double throw microswitch for a power rating of 250VAC/15A. In its MP220 version a single pole double break circuit can double-break a power line of 250VAC/10A. Operational temperature rating under EN61058 is -40°C to +130°C, but temperature rating as well as the power rating may change based on the selected potted cable material and cross section.



## Description

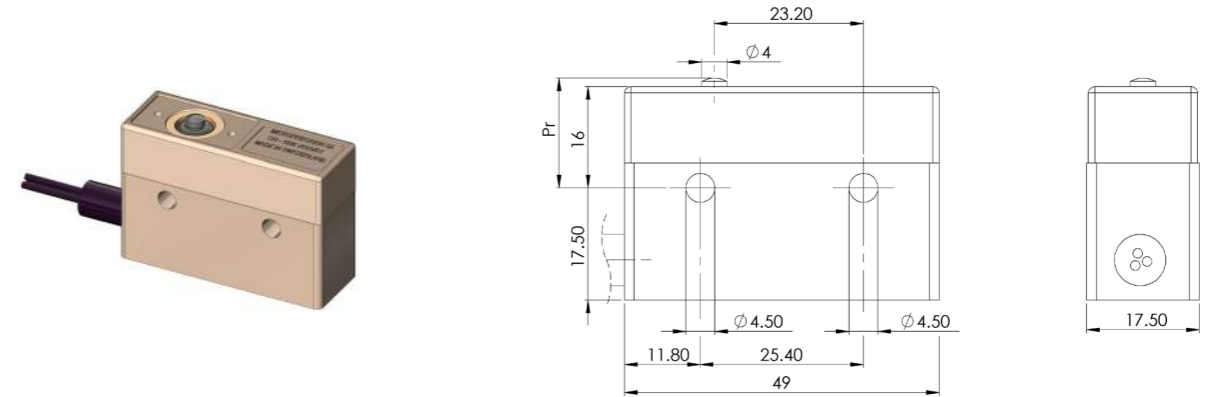

	MP210	MP220
<b>Approval</b>	EN 61058-1 250VAC/15A 50'000 cycles EN 61058-1 400VAC/10A 50'000 cycles UL 61058-1 250VAC/15A 50'000 cycles UL 61058-1 400VAC/10A 50'000 cycles CSA C22.2 250VAC/6A 6'000 cycles* Resistive load	EN 61058-1 250VAC/10A 50'000 cycles UL 61058-1 250VAC/10A 50'000 cycles Resistive load
*Optional	Resistive load	
<b>Housing</b>	Plastic reinforced with glass fiber (PBT)	Plastic reinforced with glass fiber (PBT)
<b>Pin Button</b>	PC	PC
<b>Membrane</b>	Fluorosilicone - other optional materials available	Fluorosilicone - other optional materials available
<b>Switching Circuit</b>	Change over - snap action with blade spring in copper/beryllium	Double Break - snap action with blade spring in copper/beryllium
<b>Contact</b>	Silver - optional gold	Silver - optional gold
<b>Connection</b>	Cable PVC -20°C to +105°C PVCU -20°C to +105°C (Approval UL) PUR -40°C to +90°C SI -40°C to +130°C Other material optional	Cable PVC -20°C to +105°C PVCU -20°C to +105°C (Approval UL) PUR -40°C to +90°C SI -40°C to +130°C Other material optional
<b>Actuator</b>	Stainless steel	Stainless steel
<b>Degree of Protection</b>	Housing IP67 Connection IP67	Housing IP67 Connection IP67
<b>Class of Protection</b>	II	II
<b>Micro-switching</b>	μ	μ
<b>Distance between Contacts</b>	0.80 mm	0.80 mm
<b>Dimensions</b>	DIN 41 635, form E 49 x 35 x 17.5 mm	DIN 41 635, form E 49 x 35 x 17.5 mm
<b>Actuation Force</b>	Between 0.2 to 6.0 N, depending on the lever	Between 0.2 to 6.0 N, depending on the lever
<b>Differential Travel</b>	0.05 mm - Optional 0.02 mm	0.05 mm - Optional 0.02 mm
<b>Temperature Range</b>	EN 61058-1 -40°C to +130°C UL 61058-1 -40°C to +125°C Cable selection may reduce temperature range	EN 61058-1 -40°C to +130°C UL 61058-1 -40°C to +125°C Cable selection may reduce temperature range
<b>Mechanical Life</b>	50 x 10 <sup>6</sup> cycles	50 x 10 <sup>6</sup> cycles

# Actuator

Type 0: Basic switch - Pin Button

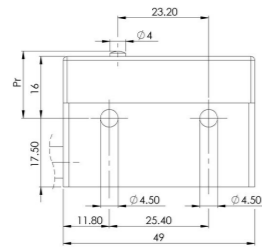

Actuating Force Fa max. (N)	6.0
Release Force Fr min. (N)	2.5
Free Position Pr (mm)	17.4 ± 0.5
Operating Position Pa (mm)	16.5 ± 0.3
Over-Travel sr min. (mm)	0.25
Differential Travel sd max. (mm)	0.10

Type 1S29: Telescopic

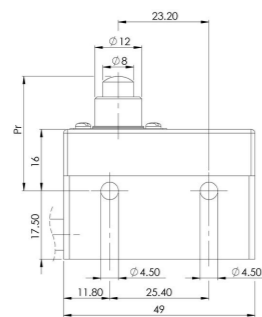

Actuating Force Fa max. (N)	6.0
Release Force Fr min. (N)	2.5
Free Position Pr (mm)	29.3 ± 0.6
Operating Position Pa (mm)	28.4 ± 0.3
Over-Travel sr min. (mm)	2.0
Differential Travel sd max. (mm)	0.12

Type 1A: Telescopic with Short Thread

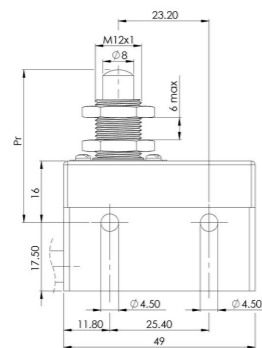
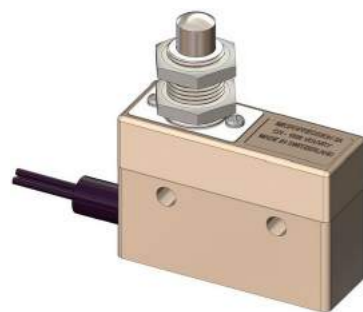

Actuating Force Fa max. (N)	6.0
Release Force Fr min. (N)	2.5
Free Position Pr (mm)	39.1 ± 0.6
Operating Position Pa (mm)	38.4 ± 0.3
Over-Travel sr min. (mm)	5.0
Differential Travel sd max. (mm)	0.12

Type 1A58: Telescopic with Thread

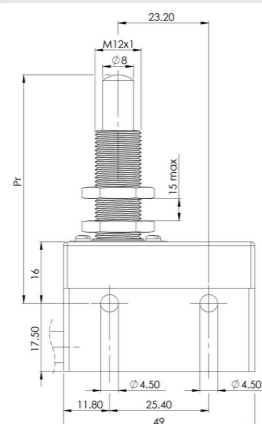
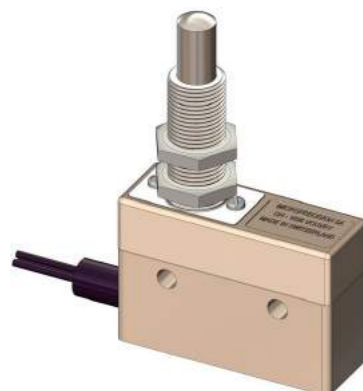

Actuating Force Fa max. (N)	6.0
Release Force Fr min. (N)	2.5
Free Position Pr (mm)	58.0 ± 1.0
Operating Position Pa (mm)	57.2 ± 0.3
Over-Travel sr min. (mm)	10.0
Differential Travel sd max. (mm)	0.12

# Actuator

Type 1BL: Telescopic with Roller

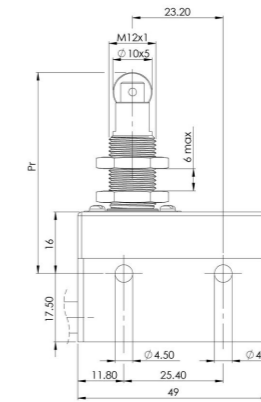
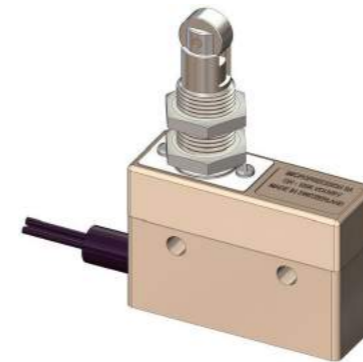

Actuating Force Fa max. (N)	6.0
Release Force Fr min. (N)	2.5
Free Position Pr (mm)	51.4 ± 0.6
Operating Position Pa (mm)	50.7 ± 0.3
Over-Travel sr min. (mm)	5.0
Differential Travel sd max. (mm)	0.12

Optional: stainless steel roller, transvers roller

Type 2A: Simple Lever - Direct Action -

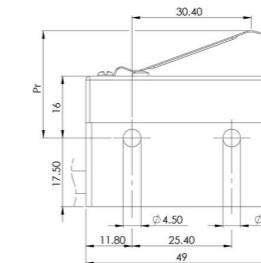

Actuating Force Fa max. (N)	3.5
Release Force Fr min. (N)	1.0
Free Position Pr (mm)	26.0 ± 2.0
Operating Position Pa (mm)	18.0 ± 2.0
Over-Travel sr min. (mm)	2.0
Differential Travel sd max. (mm)	0.80

Type 3A: Simple Lever - Indirect Action -

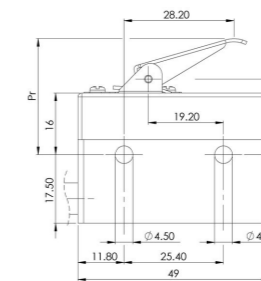
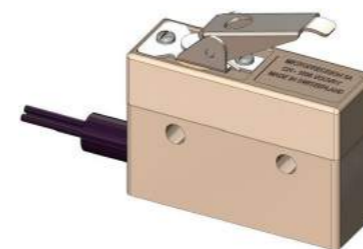

Actuating Force Fa max. (N)	4.5
Release Force Fr min. (N)	1.2
Free Position Pr (mm)	31.1 ± 1.5
Operating Position Pa (mm)	29.0 ± 1.5
Over-Travel sr min. (mm)	3.5
Differential Travel sd max. (mm)	0.80

Optional: lever mounted on opposite side

Type 4AL: Simple Lever with Roller - Direct Action -

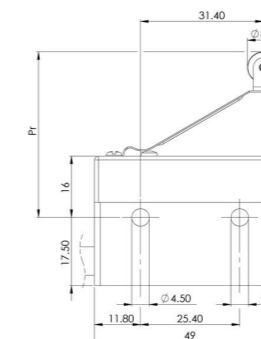
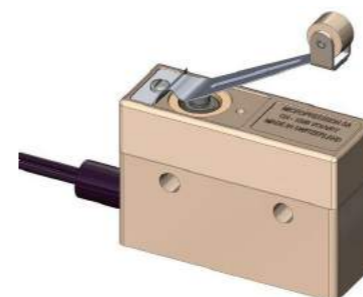

Actuating Force Fa max. (N)	3.5
Release Force Fr min. (N)	1.0
Free Position Pr (mm)	39.0 ± 2.0
Operating Position Pa (mm)	30.0 ± 2.0
Over-Travel sr min. (mm)	2.0
Differential Travel sd max. (mm)	0.80

Series MP210/220

Series MP210/220

## Actuator

Type **5AL** : Simple Lever with Roller - Indirect Action -

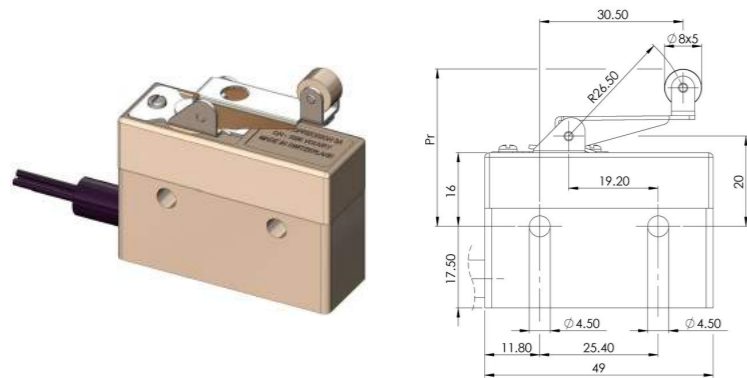

Actuating Force Fa max. (N)	4.5
Release Force Fr min. (N)	1.2
Free Position Pr (mm)	35.5 ± 1.5
Operating Position Pa (mm)	32.5 ± 1.5
Over-Travel sr min. (mm)	3.5
Differential Travel sd max. (mm)	0.90

Optional : lever mounted on opposite side, stainless steel roller, transvers roller

Type **6AL** : Simple Lever with Bending Roller - Indirect Action -

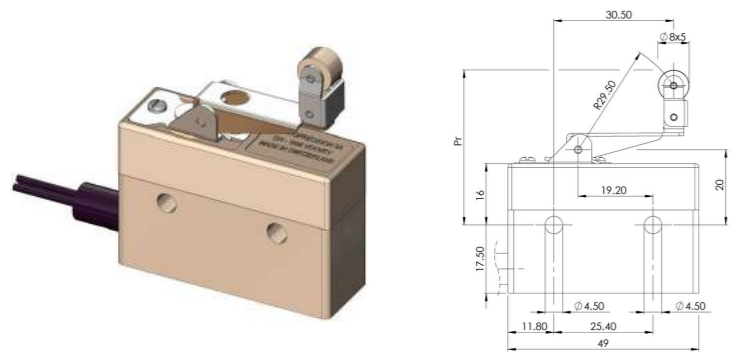

Actuating Force Fa max. (N)	4.5
Release Force Fr min. (N)	1.2
Free Position Pr (mm)	41.6 ± 1.5
Operating Position Pa (mm)	38.6 ± 1.5
Over-Travel sr min. (mm)	3.5
Differential Travel sd max. (mm)	0.90

Optional : lever mounted on opposite side, stainless steel roller, transvers roller

Type **7A40** : Simple Adjustable Lever - Direct Action -

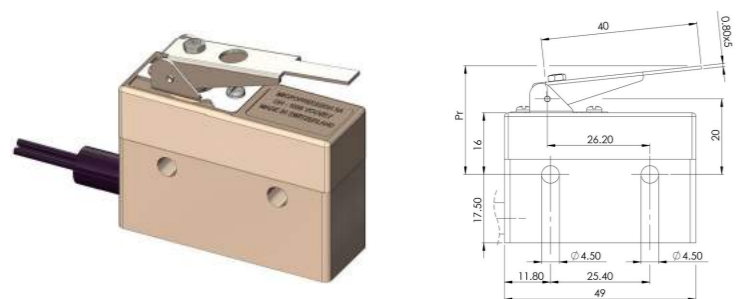

Actuating Force Fa max. (N)	0.6
Release Force Fr min. (N)	0.2
Free Position Pr (mm)	-
Operating Position Pa (mm)	Ajustable
Over-Travel sr min. (mm)	-
Differential Travel sd max. (mm)	1.20

Optional : lever mounted on opposite side

Type **7AC** : Simple Adjustable Lever with Wire - Direct Action -

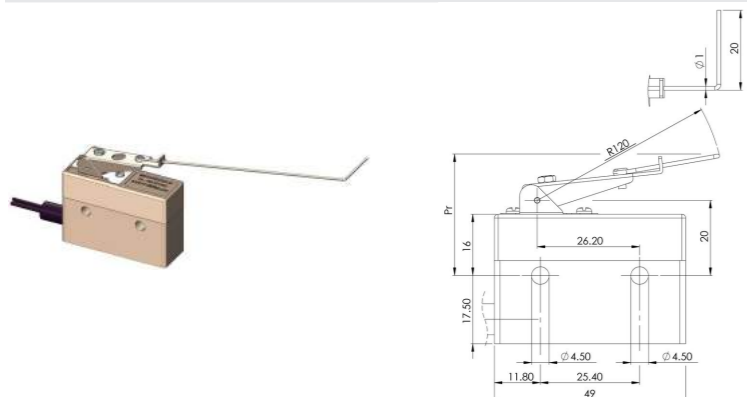

Actuating Force Fa max. (N)	0.2
Release Force Fr min. (N)	0.05
Free Position Pr (mm)	-
Operating Position Pa (mm)	Ajustable
Over-Travel sr min. (mm)	-
Differential Travel sd max. (mm)	5.00

Optional : lever mounted on opposite side

## Actuator

Type **7AF/63.5/50** : Simple Lever with Floater - Direct Action -

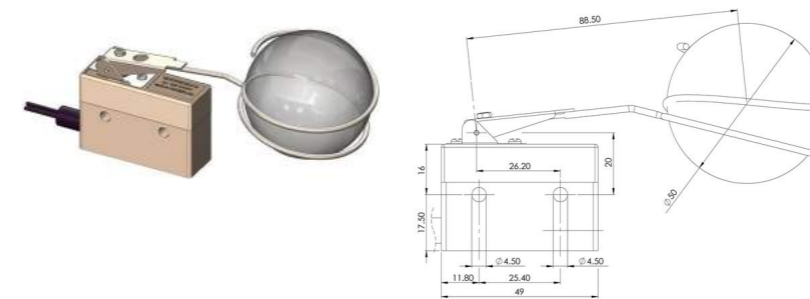

Actuating Force Fa max. (N)	-
Release Force Fr min. (N)	-
Free Position Pr (mm)	-
Operating Position Pa (mm)	Ajustable
Over-Travel sr min. (mm)	-
Differential Travel sd max. (mm)	2.00

Optional : lever mounted on opposite side

Type **8AL40** : Simple Adjustable Lever with Roller - Direct Action -

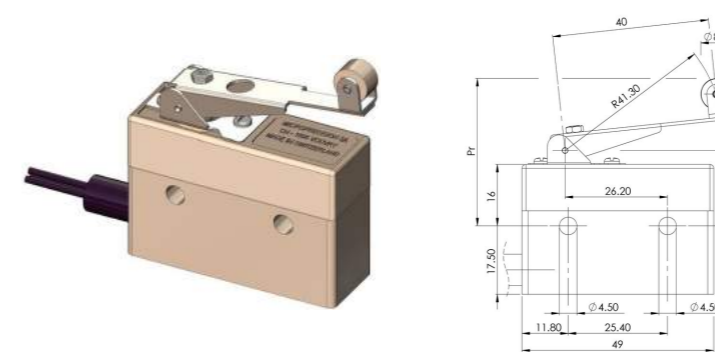

Actuating Force Fa max. (N)	0.6
Release Force Fr min. (N)	0.2
Free Position Pr (mm)	-
Operating Position Pa (mm)	Ajustable
Over-Travel sr min. (mm)	-
Differential Travel sd max. (mm)	1.20

Optional : lever mounted opposite side, stainless steel roller, transvers roller

## Electrical Circuit

	Actuator Code	Circuit	Color
Direct Action	0 1S29 1A 1A58 1BL 2A 4AL 7A40 7AC 7AF/63.5/50 8AL40		<b>PVC / PVCU:</b> 1 / Brown - 2 / Black - 4 / Blue <b>SI:</b> 1 / Red - 2 / White - 4 / Blue <b>PUR:</b> 1 / Red - 2 / White - 4 / Blue
			<b>PVC / PVCU:</b> 11/12 - Brown ; 23/24 - Blue <b>SI:</b> 11/12 - White ; 23/24 - Blue <b>PUR:</b> 11/12 - Brown ; 23/24 - Blue
Indirect Action	3A 5AL 6AL		<b>PVC / PVCU:</b> 1 / Brown - 2 / Black - 4 / Blue <b>SI:</b> 1 / Red - 2 / White - 4 / Blue <b>PUR:</b> 1 / Red - 2 / White - 4 / Blue
			<b>PVC / PVCU:</b> 11/12 - Brown ; 23/24 - Blue <b>SI:</b> 11/12 - White ; 23/24 - Blue <b>PUR:</b> 11/12 - Brown ; 23/24 - Blue

## Ordering Information

	MP2	1	0	-	5AL	/	3	100	/	200	SI
<b>Circuit</b>											
1:											
2:											
<b>Contact</b>											
0:											
1:											
<b>Actuator</b>											
0:											
1S29:											
1A:											
1A58:											
1BL:											
2A:											
3A:											
4AL:											
5AL:											
6AL:											
7A40:											
7AC:											
7AF/63.5/50:											
8AL40:											
<b>Number of conductors</b>											
3:											
4:											
<b>Cross section</b>											
100:											
150:											
<b>Cable length in centimeters (cm)</b>											
<b>Cable material</b>											
PVC:											
PVCU:											
PUR:											
SI:											

# Microswitch - SERIES MP215/225



## MP215/225

The MP215/225 is an IP68 sealed snap action microswitch with potted cable for very demanding industrial applications. With its strengthened cable outlet and increased actuating force it can operate completely immersed in liquids. All actuators are stainless steel for maximum protection in hazardous industrial environments.

The switch can be supplied with two different electrical circuits. The MP215 version is a single pole double throw microswitch for a power rating of 400VAC/10A. In its MP225 version a single pole double break circuit can double-break a power line of up to 250VAC/10A.



## Description

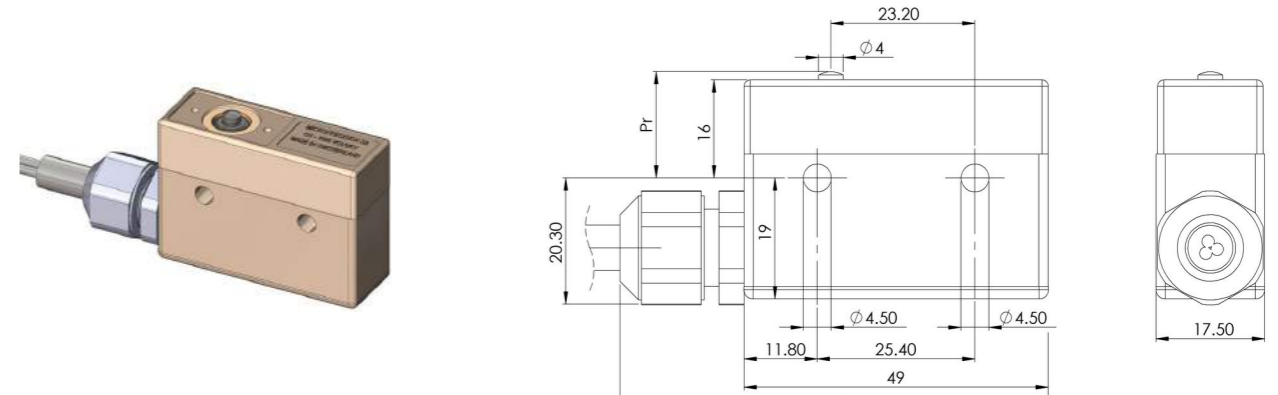

	MP215	MP225
<b>Approval</b>	EN 61058-1 400VAC/10A 50'000 cycles Resistive load	EN 61058-1 250VAC/10A 50'000 cycles Resistive load
<b>Housing</b>	Plastic reinforced with glass fiber (PBT)	Plastic reinforced with glass fiber (PBT)
<b>Pin Button</b>	PC	PC
<b>Membrane</b>	Fluorosilicone - other optional materials available	Fluorosilicone - other optional materials available
<b>Switching Circuit</b>	Change over - snap action with blade spring in copper/beryllium	Double Break - snap action with blade spring in copper/beryllium
<b>Contact</b>	Silver - optional gold	Silver - optional gold
<b>Connection</b>	Cable with PG PVC PG -20°C to +100°C PUR PG -20°C to +90°C SIPG -20°C to +100°C Other material optional	Cable with PG PVC PG -20°C to +100°C PUR PG -20°C to +90°C SIPG -20°C to +100°C Other material optional
<b>Actuator</b>	Stainless steel	Stainless steel
<b>Degree of Protection</b>	Housing IP68 (2bar) Connection IP68 (2bar)	Housing IP68 (2bar) Connection IP68 (2bar)
<b>Class of Protection</b>	II	II
<b>Micro-switching</b>	μ	μ
<b>Distance between Contacts</b>	0.80 mm	0.80 mm
<b>Dimensions</b>	DIN 41 635, form E 49 x 35 x 17.5 mm	DIN 41 635, form E 49 x 35 x 17.5 mm
<b>Actuation Force</b>	12N	12N
<b>Differential Travel</b>	0.10 mm	0.10 mm
<b>Temperature Range</b>	EN 61058-1 -40°C to +130°C Cable selection may reduce temperature range	EN 61058-1 -40°C to +130°C Cable selection may reduce temperature range
<b>Mechanical Life</b>	50 x 10 <sup>6</sup> cycles	50 x 10 <sup>6</sup> cycles

Series MP215/225

Series MP215/225



## Actuator

Type 0: Basic switch - Pin Button

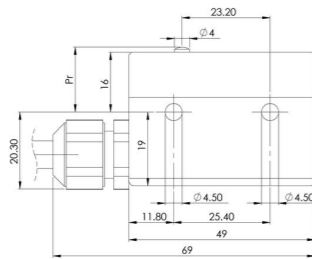

Actuating Force Fa max. (N)	12.5
Release Force Fr min. (N)	6
Free Position Pr (mm)	17.4 ± 0.5
Operating Position Pa (mm)	16.5 ± 0.3
Over-Travel sr min. (mm)	0.25
Differential Travel sd max. (mm)	0.10

Type 1ACEA: Telescopic with Short Thread

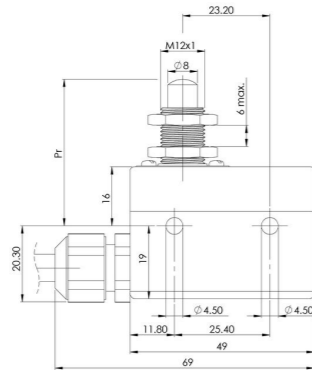
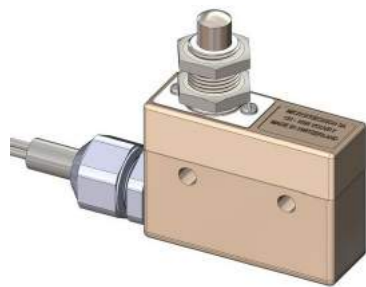

Actuating Force Fa max. (N)	12.5
Release Force Fr min. (N)	6
Free Position Pr (mm)	39.1 ± 0.6
Operating Position Pa (mm)	38.3 ± 0.3
Over-Travel sr min. (mm)	5.0
Differential Travel sd max. (mm)	0.12

Type 1BLACEA: Telescopic with Stainless steel Roller

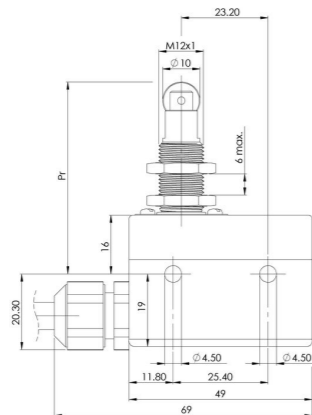
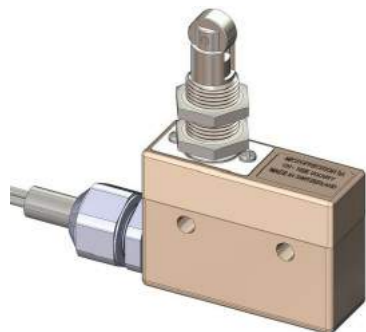

Actuating Force Fa max. (N)	12.5
Release Force Fr min. (N)	6
Free Position Pr (mm)	51.4 ± 0.6
Operating Position Pa (mm)	50.4 ± 0.3
Over-Travel sr min. (mm)	5.0
Differential Travel sd max. (mm)	0.12

## Electrical Circuit

	Actuator Code	Circuit	Color
Direct Action	0 1ACEA 1BLACEA		<b>PVC / PVCU:</b> 1 / Brown - 2 / Black - 4 / Blue <b>SI:</b> 1 / Red - 2 / White - 4 / Blue <b>PUR:</b> 1 / Red - 2 / White - 4 / Blue
			<b>PVC/ PVCU:</b> 11/12 - Brown ; 23/24 - Blue <b>SI:</b> 11/12 - White ; 23/24 - Blue <b>PUR:</b> 11/12 - Brown ; 23/24 - Blue

## Ordering Information

	MP2	1	5	-	1ACEA	/	3	100	/	200	SIPG
<b>Circuit</b>											
1:											
2:											
<b>Actuator</b>											
0:											
1ACEA:											
1BLACEA:											
<b>Number of conductors</b>											
3:											
4:											
<b>Cross section</b>											
100:											
<b>Cable length in centimeters (cm)</b>											
<b>Cable material</b>											
PVCPG:											
PVCUPG:											
PURPG:											
SIPG:											

# Microswitch - SERIES MP300

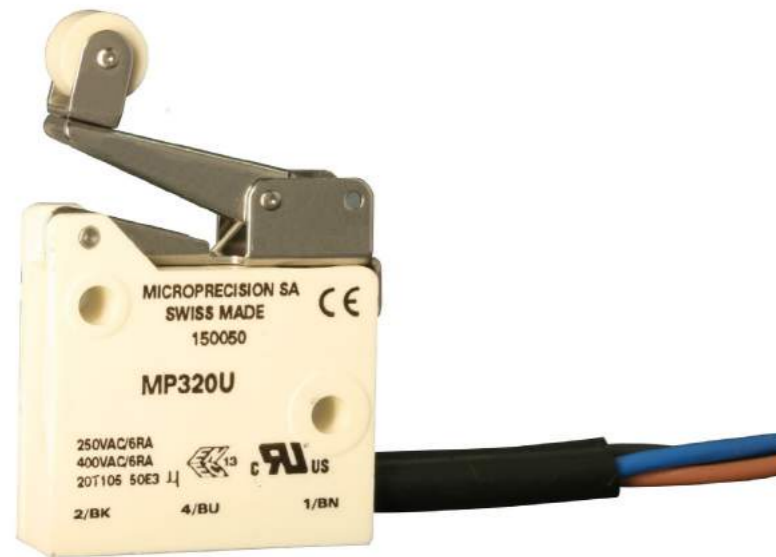

## MP300

A versatile miniature IP67 microswitch with a temperature range up to 170°C and stainless steel levers. Ideal for a wide range of applications, including those in the most demanding industrial environments. The MP300 Series features unparalleled flexibility in terms of levers and telescopic plungers. Small differential travel, large choice of cable and wire connections makes this switch a perfect solution for industrial OEM customers.



## Description

### MP310

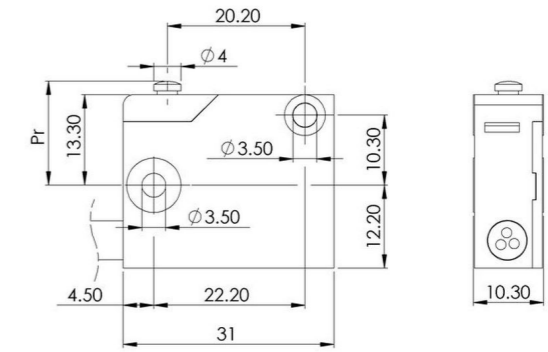

### MP320

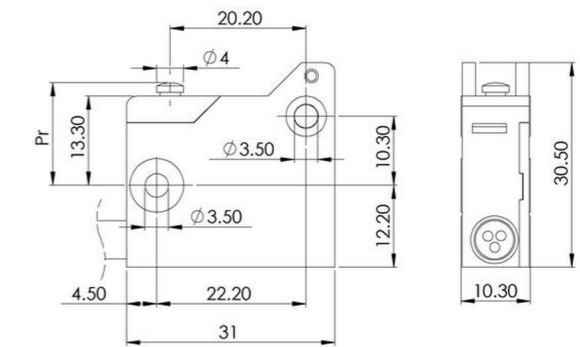

Series MP300 offers the choice of two housings:

MP310: reduced height without the possibility to mount additional actuators

MP320: mounting extension for actuators

Series MP300

Series MP300

## Description

### MP310 / MP320

Approval	EN 61058-1	250VAC/6A	50'000 cycles
	EN 61058-1	400VAC/6A	50'000 cycles*
	UL 61058-1	250VAC/6A	50'000 cycles
	UL 61058-1	400VAC/6A	50'000 cycles*
	CSA C22.2	250VAC/6A	6'000 cycles*
	ATEX 113d/Ex t IIIB	84°C Dc	250VAC/6A*
*Optional	Resistive load		

Housing	Plastic reinforced with glass fiber (PBT or PPS for high temperature or ATEX)
Pin Button	PPS
Membrane	Fluorosilicone - other optional materials available
Switching Circuit	Change over - snap action with blade spring in copper/beryllium
Contact	Silver - optional gold
Connection	Cable Various cable exit option : Standard - Opposite - Underside PVC -20°C to +105°C PVCU -20°C to +105°C (Approval UL) PUR -40°C to +90°C SI -40°C to +130°C PTFE -40°C to +170°C Other material optional
Actuator	Stainless steel

Degree of Protection	Housing IP67 Connection IP67
Class of Protection	II
Micro-switching	μ
Distance between Contacts	0.80 mm
Dimensions	DIN 41 635, form E 31 x 24 x 10.3 mm

Actuation Force	1.3 to 4.0 N, depending on the lever
Differential Travel	0.05 mm - Optional 0.02 mm
Temperature Range	EN 61058-1 -40°C to +170°C UL 61058-1 -40°C to +130°C CSA 22.2 T amb. ATEX -15°C to +80°C Cable selection may reduce temperature range
Mechanical Life	50 x 10 <sup>6</sup> cycles

## Actuator

### Type 0: Basic switch - Pin Button

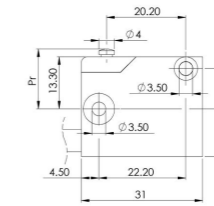

Actuating Force Fa max. (N)	3.5
Release Force Fr min. (N)	1.0
Free Position Pr (mm)	15.3 ± 0.3
Operating Position Pa (mm)	14.7 ± 0.2
Over-Travel sr min. (mm)	0.20
Differential Travel sd max. (mm)	0.05

### Type 1MS27: Telescopic

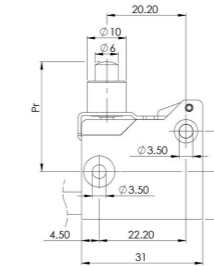
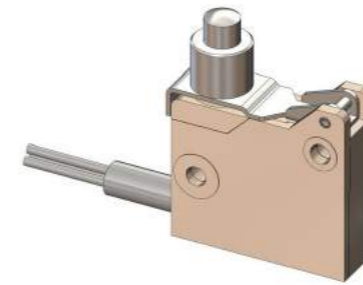

Actuating Force Fa max. (N)	3.5
Release Force Fr min. (N)	1.0
Free Position Pr (mm)	27.7 ± 0.6
Operating Position Pa (mm)	27.2 ± 0.3
Over-Travel sr min. (mm)	2.0
Differential Travel sd max. (mm)	0.1

### Type 1M: Telescopic with Thread

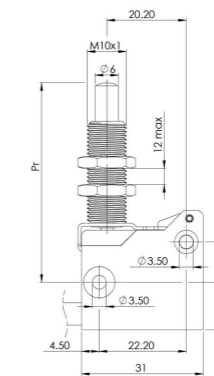
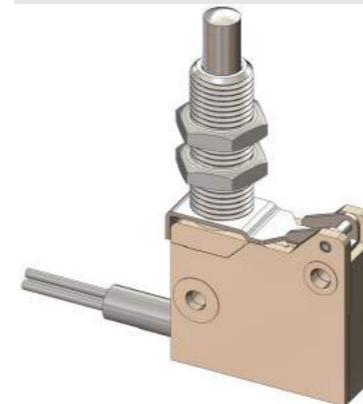

Actuating Force Fa max. (N)	3.5
Release Force Fr min. (N)	1.0
Free Position Pr (mm)	50.3 ± 0.6
Operating Position Pa (mm)	49.7 ± 0.3
Over-Travel sr min. (mm)	5.0
Differential Travel sd max. (mm)	0.1

### Type 1ML: Telescopic with Stainless Steel Roller

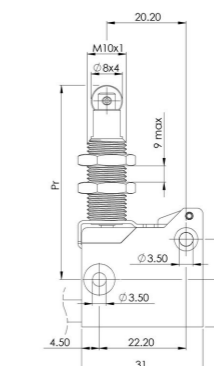
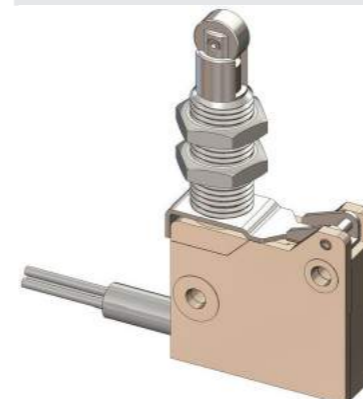

Actuating Force Fa max. (N)	3.5
Release Force Fr min. (N)	1.0
Free Position Pr (mm)	49.8 ± 0.6
Operating Position Pa (mm)	48.3 ± 0.3
Over-Travel sr min. (mm)	5.0
Differential Travel sd max. (mm)	0.1

Optional: transvers roller

## Actuator

Type **3MA**: Simple Lever - Indirect Action -

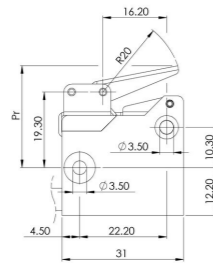
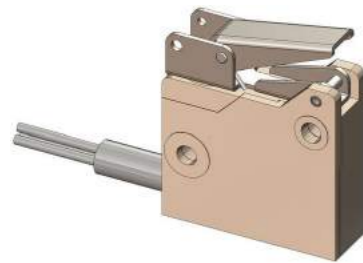

Actuating Force Fa max. (N)	2.5
Release Force Fr min. (N)	1.0
Free Position Pr (mm)	26.0 ± 1.0
Operating Position Pa (mm)	24.2 ± 0.6
Over-Travel sr min. (mm)	2.5
Differential Travel sd max. (mm)	0.8

Optional: lever mounted on opposite side

Type **5MAL**: Simple Lever with Roller - Indirect Action -

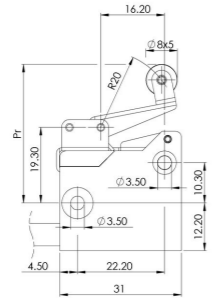
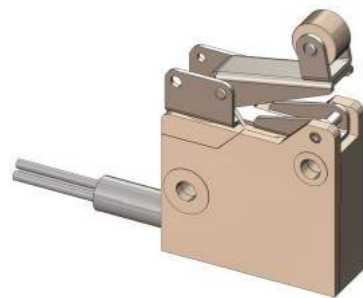

Actuating Force Fa max. (N)	3.0
Release Force Fr min. (N)	1.0
Free Position Pr (mm)	35.6 ± 1.0
Operating Position Pa (mm)	34.0 ± 0.6
Over-Travel sr min. (mm)	2.5
Differential Travel sd max. (mm)	0.8

Optional: lever mounted on opposite side, stainless steel roller (5MALA), transvers roller

Type **6MAL**: Simple Lever with Bending Roller - Indirect Action -

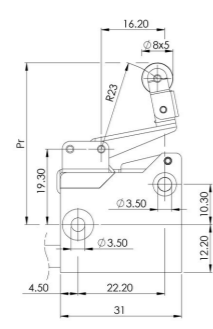
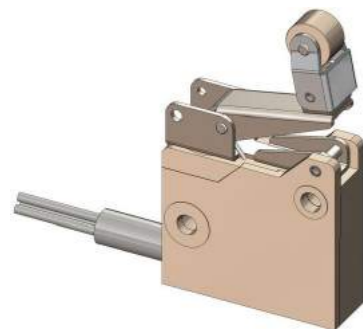

Actuating Force Fa max. (N)	3.0
Release Force Fr min. (N)	1.0
Free Position Pr (mm)	41.5 ± 1.0
Operating Position Pa (mm)	39.8 ± 0.6
Over-Travel sr min. (mm)	2.5
Differential Travel sd max. (mm)	0.8

Optional: lever mounted on opposite side, stainless steel roller (6MALA), transvers roller

Type **7M26**: Simple Lever - Direct Action -

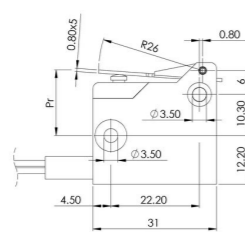

Actuating Force Fa max. (N)	3.5
Release Force Fr min. (N)	1.0
Free Position Pr (mm)	17.0 ± 1.0
Operating Position Pa (mm)	16.0 ± 0.3
Over-Travel sr min. (mm)	0.2
Differential Travel sd max. (mm)	0.1

## Actuator

Type **7M**: Simple Lever - Direct Action -

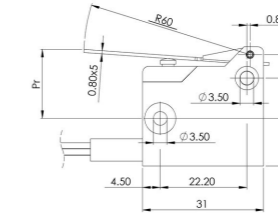
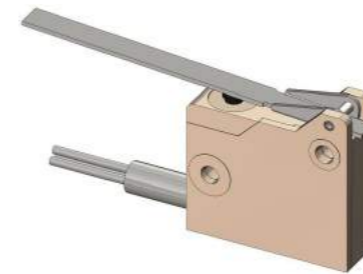

Actuating Force Fa max. (N)	1.3
Release Force Fr min. (N)	0.3
Free Position Pr (mm)	19.0 ± 1.0
Operating Position Pa (mm)	16.5 ± 0.8
Over-Travel sr min. (mm)	0.5
Differential Travel sd max. (mm)	0.8

Type **7MAF/127/50**: Simple Lever with Floater - Indirect Action -

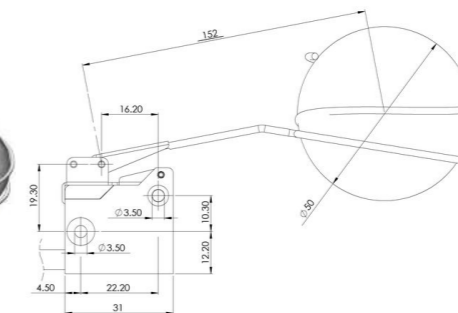

Actuating Force Fa max. (N)	-
Release Force Fr min. (N)	-
Free Position Pr (mm)	-
Operating Position Pa (mm)	-
Over-Travel sr min. (mm)	-
Differential Travel sd max. (mm)	2.00

Type **8ML25**: Simple Lever with Roller - Direct Action -

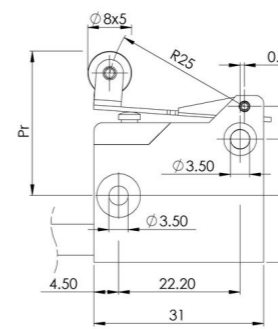
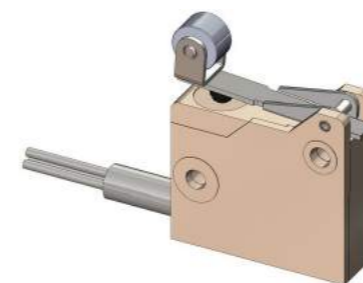

Actuating Force Fa max. (N)	3.5
Release Force Fr min. (N)	1.0
Free Position Pr (mm)	26.5 ± 1.0
Operating Position Pa (mm)	25.7 ± 0.3
Over-Travel sr min. (mm)	0.2
Differential Travel sd max. (mm)	0.1

Optional: stainless steel roller, transvers roller

## Electrical Circuit

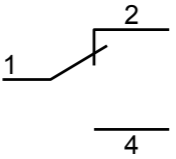
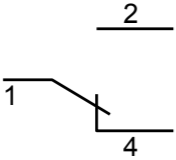
	Actuator Code	Circuit	Color
Direct Action	0		1: Brown 2: Black 4: Blue
	1MS27		
	1M		
	1ML		
	7M		
Indirect Action	7M26		1: Brown 2: Black 4: Blue
	8ML25		
	3MA		
	5MAL		
	6MAL		
	7MAF/127/50		

## Optional cable and wire exit

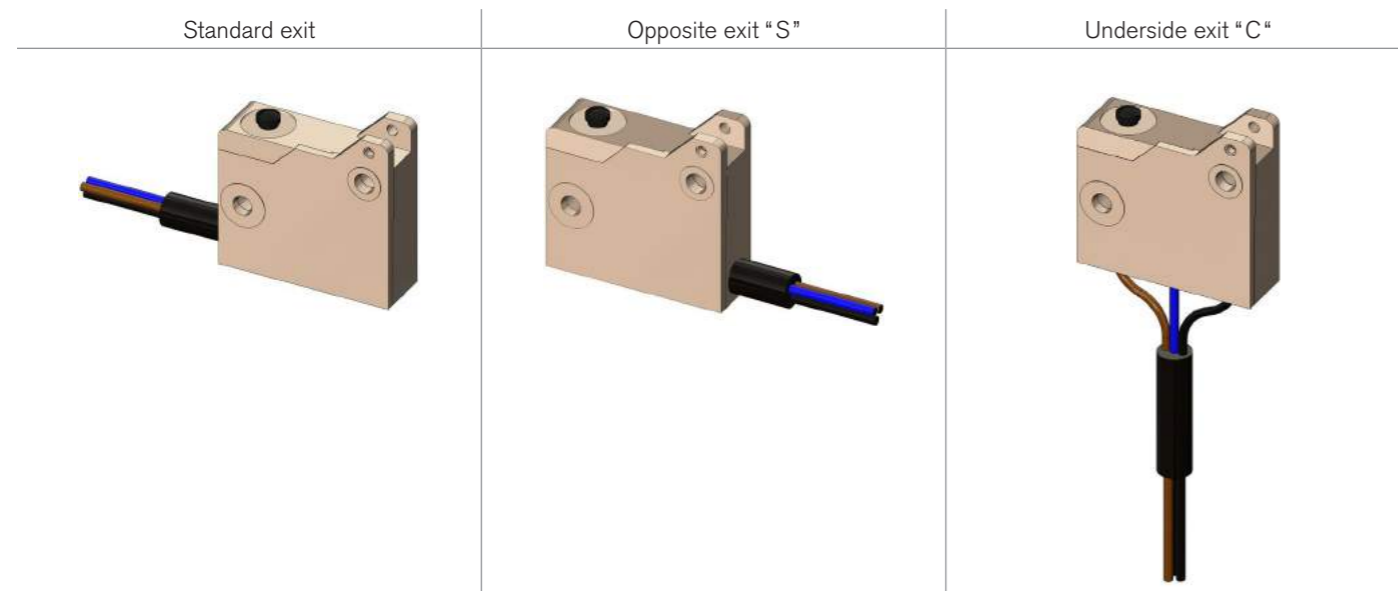

## Ordering Information

		MP3	2	0	-	8ML25	/	3	75	/	100	PVC
<b>Housing</b>												
1:	Without Actuator											
2:	With Actuator											
<b>Contact</b>												
0:	Silver Contact											
1:	Gold Contact											
<b>Actuator</b>												
0:	Basic switch - Pin Button											
1MS27:	Telescopic											
1M:	Telescopic with Thread											
1ML:	Telescopic with Stainless Steel Roller											
3MA:	Simple Lever - Indirect Action											
5MAL:	Simple Lever with Roller - Indirect Action											
6MAL:	Simple Lever with Bending Roller - Indirect Action											
7M26:	Simple Lever - Direct Action											
7M:	Simple Lever - Direct Action											
7MAF/127/50:	Simple Lever with Floater - Indirect Action											
8ML25:	Simple Lever with Roller - Direct Action											
<b>Number of conductors</b>												
3:	Single Break											
<b>Cross section</b>												
75:	0.75 mm <sup>2</sup> / 19AWG											
<b>Cable length in centimeters (cm)</b>												
<b>Cable material</b>												
PVC:	Polyvinyl Chloride -20°C to +105°C											
PVCU:	Polyvinyl Chloride -20°C to +105°C (Approval UL)											
PUR:	Polyurethane -40°C to +90°C											
SI:	Silicone -40°C to +130°C											
PTFE:	Polytetrafluoroethylene -40°C to +170°C (Actuator while stainless steel)											
<b>Optional cable and wire exit</b>												
	Standard exit - without code											
S:	Opposite exit											
C:	Underside exit											

Series MP300

Series MP300

# Microswitch - SERIES MP400



## MP400

Small standardized subminiature microswitch. The MP400 Series offers various possibilities of customization in the area of levers and cable choices. The switch is ideal for numerous applications with its small size, combined with high precision and small differential travel.



## Description

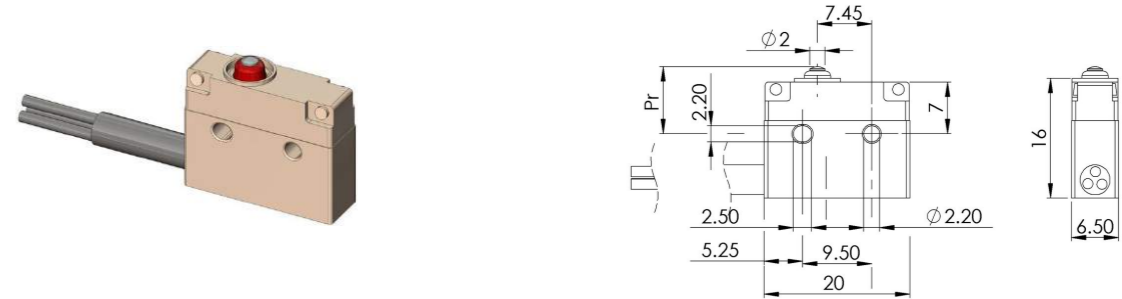

## MP400

<b>Approval</b>	EN 61058-1 250VAC/5A 25'000 cycles EN 61058-1 250VAC/2A 50'000 cycles UL 61058-1 250VAC/5A 25'000 cycles UL 61058-1 250VAC/2A 50'000 cycles Resistive load
<b>Housing</b>	Plastic reinforced with glass fiber (PA 6T/66)
<b>Pin Button</b>	PES
<b>Membrane</b>	Fluorosilicone
<b>Switching Circuit</b>	Change over - snap action with blade spring in copper/beryllium and stainless steel spring
<b>Contact</b>	Silver - optional gold
<b>Connection</b>	Cable Various cable exit option: Standard - Opposite - Underside PVC -20°C to +70°C PVCU -20°C to +70°C (Approval UL) PUR -40°C to +90°C SI -40°C to +105°C Other material optional
<b>Actuator</b>	Stainless steel
<b>Degree of Protection</b>	Housing IP67 Connection IP67
<b>Class of Protection</b>	II
<b>Micro-switching</b>	μ
<b>Distance between Contacts</b>	0.40 mm
<b>Dimensions</b>	DIN 41 635, form B 20 x 16 x 6.5 mm
<b>Actuation Force</b>	1.0 to 2.5 N, depending on the lever
<b>Differential Travel</b>	0.05 mm - Optional 0.02 mm
<b>Temperature Range</b>	EN 61058-1 -40°C to +105°C UL 61058-1 -40°C to +105°C Cable selection may reduce temperature range
<b>Mechanical Life</b>	10 x 10 <sup>6</sup> cycles

## Actuator

Type 0: Basic switch - Pin Button

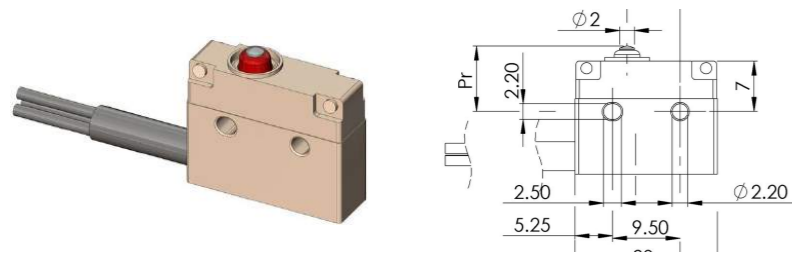

Actuating Force $F_a$ max. (N)	2.5
Release Force $F_r$ min. (N)	0.5
Free Position $P_r$ (mm)	$9.3 \pm 0.2$
Operating Position $P_a$ (mm)	$9.0 \pm 0.2$
Over-Travel $s_r$ min. (mm)	0.6
Differential Travel $s_d$ max. (mm)	0.05

Type 7JA: Simple Lever - position A

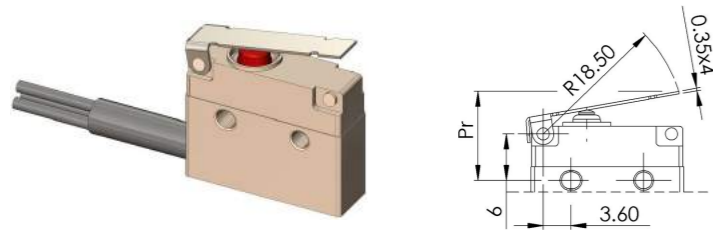

Actuating Force $F_a$ max. (N)	1.0
Release Force $F_r$ min. (N)	0.15
Free Position $P_r$ (mm)	$12.0 \pm 0.4$
Operating Position $P_a$ (mm)	$10.6 \pm 0.4$
Over-Travel $s_r$ min. (mm)	1.2
Differential Travel $s_d$ max. (mm)	0.40

Type 7JB-: Simple Lever - position B

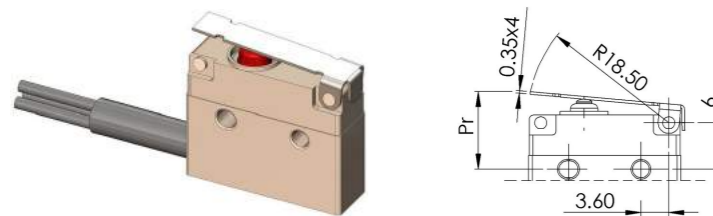

Actuating Force $F_a$ max. (N)	2.0
Release Force $F_r$ min. (N)	0.3
Free Position $P_r$ (mm)	$10.3 \pm 0.4$
Operating Position $P_a$ (mm)	$9.7 \pm 0.4$
Over-Travel $s_r$ min. (mm)	0.6
Differential Travel $s_d$ max. (mm)	0.30

Type 8JAL: Simple Lever with Roller - position A

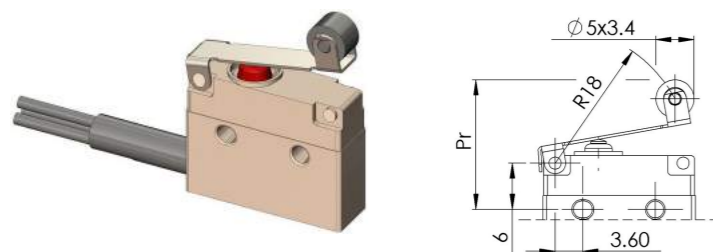

Actuating Force $F_a$ max. (N)	1.0
Release Force $F_r$ min. (N)	0.15
Free Position $P_r$ (mm)	$17.2 \pm 0.4$
Operating Position $P_a$ (mm)	$16.0 \pm 0.4$
Over-Travel $s_r$ min. (mm)	1.2
Differential Travel $s_d$ max. (mm)	0.40

## Actuator

Type 8JBL: Simple Lever with Roller - position B

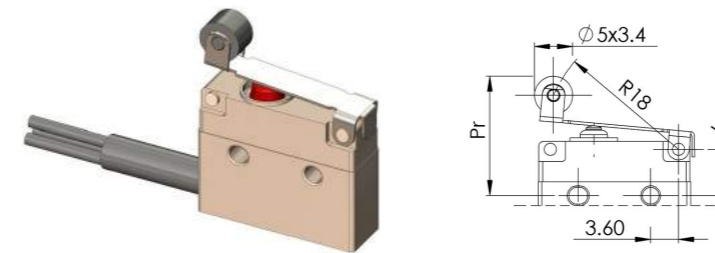

Actuating Force $F_a$ max. (N)	2.0
Release Force $F_r$ min. (N)	0.3
Free Position $P_r$ (mm)	$15.7 \pm 0.4$
Operating Position $P_a$ (mm)	$15.1 \pm 0.4$
Over-Travel $s_r$ min. (mm)	0.6
Differential Travel $s_d$ max. (mm)	0.30

Type 8JAGS: Simple Lever with Simulated Roller - position A

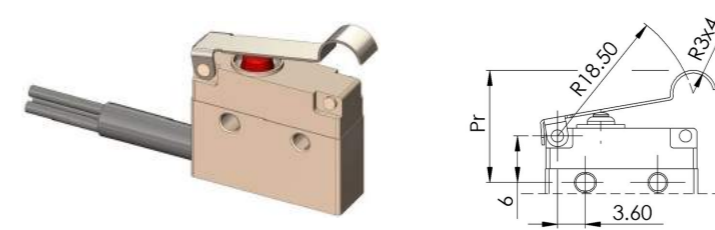

Actuating Force $F_a$ max. (N)	1.0
Release Force $F_r$ min. (N)	0.15
Free Position $P_r$ (mm)	$14.7 \pm 0.4$
Operating Position $P_a$ (mm)	$13.5 \pm 0.4$
Over-Travel $s_r$ min. (mm)	1.2
Differential Travel $s_d$ max. (mm)	0.40

Type 8JBGS: Simple Lever with Simulated Roller - position B

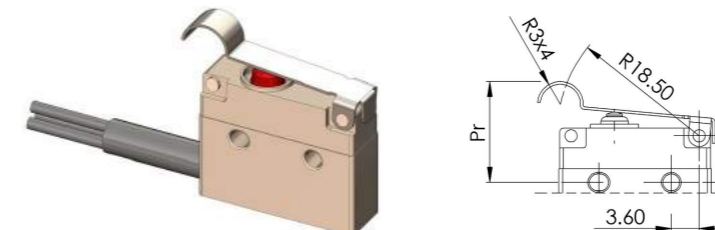

Actuating Force $F_a$ max. (N)	2.0
Release Force $F_r$ min. (N)	0.3
Free Position $P_r$ (mm)	$13.2 \pm 0.4$
Operating Position $P_a$ (mm)	$12.6 \pm 0.4$
Over-Travel $s_r$ min. (mm)	0.6
Differential Travel $s_d$ max. (mm)	0.30

## Electrical Circuit

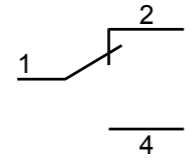
Actuator Code	Circuit	Color
0 7JA / 7JB 8JAL / 8JBL 8JAGS / 8JBGS		1: Brown 2: White 4: Green

## Optional cable and wire exit

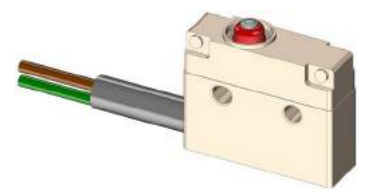
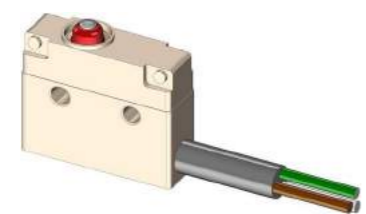
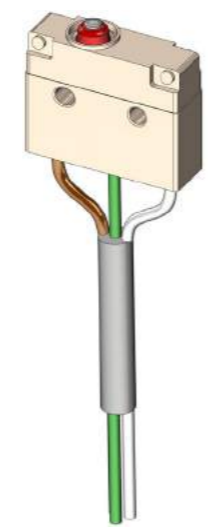
Standard exit	Opposite exit "S"	Underside exit "C"
		

## Ordering Information

		MP43	0	-	7JA	/	3	25	/	100	PVC
<b>Contact</b>											
<b>0:</b>	Silver Contact										
<b>1:</b>	Gold Contact										
<b>Actuator</b>											
<b>0:</b>	Basic switch - Pin Button										
<b>7JA:</b>	Simple Lever - position A										
<b>7JB:</b>	Simple Lever - position B										
<b>8JAL:</b>	Simple Lever with Roller - position A										
<b>8JBL:</b>	Simple Lever with Roller - position B										
<b>8JAGS:</b>	Simple Lever with simulated Roller - position A										
<b>8JBGS:</b>	Simple Lever with simulated Roller - position B										
<b>Number of conductors</b>											
<b>3:</b>	Change over										
<b>Cross section</b>											
<b>25:</b>	0.25mm <sup>2</sup> , 250VAC / 2A										
<b>50:</b>	0.50mm <sup>2</sup> , 250VAC / 5A (PVC only)										
<b>Cable length in centimeters (cm)</b>											
<b>Cable material</b>											
<b>PVC:</b>	Polyvinyl Chloride -20°C to +70°C										
<b>PVCU:</b>	Polyvinyl Chloride -20°C to +70°C (Approval UL)										
<b>PUR:</b>	Polyurethane -40°C to +90°C										
<b>SI:</b>	Silicone -40°C to +105°C										
<b>Optional cable and wire exit</b>											
	Standard exit - without code										
<b>S:</b>	Opposite exit										
<b>C:</b>	Underside exit										



# Microswitch - SERIES MP500



## MP500

A subminiature microswitch of standardized small dimensions. The MP500 Series provides long mechanical service, small differential travel and wide temperature range up to 105°C.

## Description

### C000 : Solder Lugs

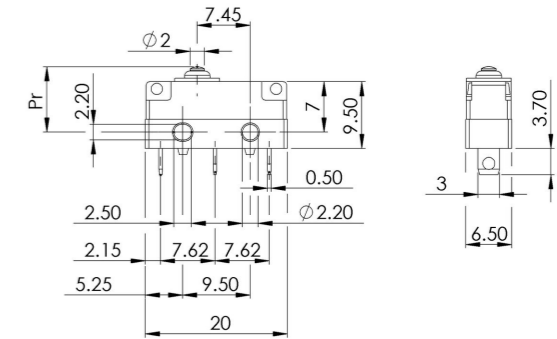

Use flexible wires.  
Prevent moving wire to protect solder joint.

Prevent any overheating of the solder lugs as this could damage the microswitch. Limit temperature of solder iron to 340°C max. Apply iron for maximum 4 seconds and use solder wire without chlorine.

### C001 : PCB Connection

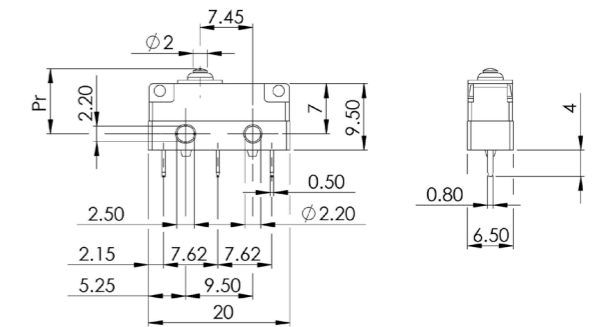

### C100 : PVC potted cable

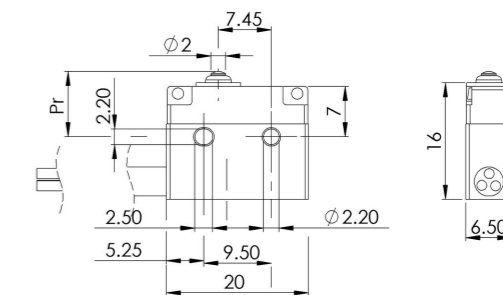
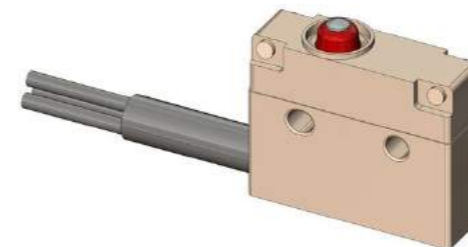

Series MP500

Series MP500

## Description

### MP500

<b>Approval</b>	EN 61058-1	250VAC/5A	25'000 cycles
	EN 61058-1	250VAC/2A	50'000 cycles
	UL 61058-1	250VAC/5A	25'000 cycles
	UL 61058-1	250VAC/2A	50'000 cycles
	Resistive load		
<b>Housing</b>	Plastic reinforced with glass fiber (PA 6T/66)		
<b>Pin Button</b>	PES		
<b>Membrane</b>	Fluorosilicone		
<b>Switching Circuit</b>	Change over - snap action with blade spring in copper/beryllium and stainless steel spring		
<b>Contact</b>	Silver - optional gold		
<b>Connection</b>	Cable PVC	-20°C to +105°C	
	PCB	-40°C to +105°C	
	Solder Lugs	-40°C to +105°C	
<b>Actuator</b>	Stainless steel		
<b>Degree of Protection</b>	Housing	IP67 / IP40	
	Connection Cable	IP67	
	PCB	IP00	
	Solder Lugs	IP00	
<b>Class of Protection</b>	II		
<b>Micro-switching</b>	μ		
<b>Distance between Contacts</b>	0.40 mm		
<b>Dimensions</b>	DIN 41 635, form B 20 x 16 x 6.5 mm		
<b>Actuation Force</b>	0.6 to 2.5 N, depending on the lever		
<b>Differential Travel</b>	0.05 mm		
<b>Temperature Range</b>	EN 61058-1	-40°C to +105°C	
	UL 61058-1	-40°C to +105°C	
Cable selection may reduce temperature range			
<b>Mechanical Life</b>	10 x 10 <sup>6</sup> cycles		

## Actuator

### Type L00 : Basic switch - Pin Button

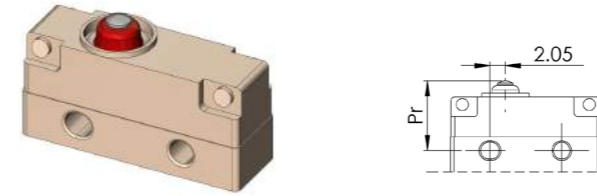

	MP500/550	MP520/570
<b>Actuating Force Fa max. (N)</b>	2.5	1.2
<b>Release Force Fr min. (N)</b>	0.5	0.2
<b>Free Position Pr (mm)</b>	9.3 ± 0.2	9.3 ± 0.2
<b>Operating Position Pa (mm)</b>	9.0 ± 0.2	9.0 ± 0.2
<b>Over-Travel sr min. (mm)</b>	0.6	0.6
<b>Differential Travel sd max. (mm)</b>	0.05	0.05

### Type L70 : Simple Lever - position A

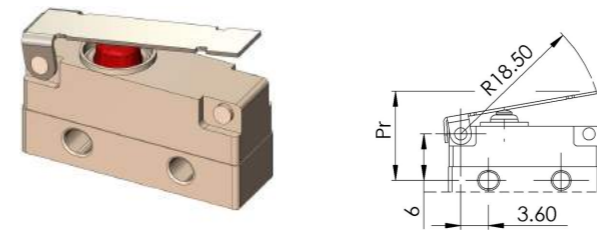

	MP500/550	MP520/570
<b>Actuating Force Fa max. (N)</b>	1.0	0.6
<b>Release Force Fr min. (N)</b>	0.15	0.1
<b>Free Position Pr (mm)</b>	12.0 ± 0.4	12.0 ± 0.4
<b>Operating Position Pa (mm)</b>	10.6 ± 0.4	10.6 ± 0.4
<b>Over-Travel sr min. (mm)</b>	1.2	1.2
<b>Differential Travel sd max. (mm)</b>	0.40	0.40

### Type L71 : Simple Lever - position B

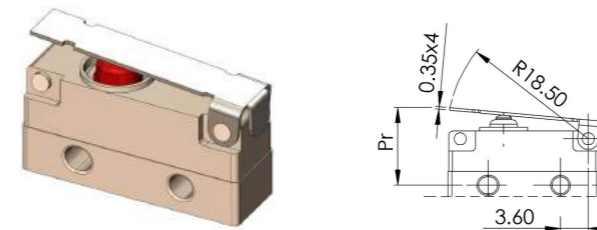

	MP500/550	MP520/570
<b>Actuating Force Fa max. (N)</b>	2.0	1.0
<b>Release Force Fr min. (N)</b>	0.3	0.2
<b>Free Position Pr (mm)</b>	10.3 ± 0.4	10.3 ± 0.4
<b>Operating Position Pa (mm)</b>	9.7 ± 0.4	9.7 ± 0.4
<b>Over-Travel sr min. (mm)</b>	0.6	0.6
<b>Differential Travel sd max. (mm)</b>	0.30	0.30

### Type L80 : Simple Lever with Roller - position A

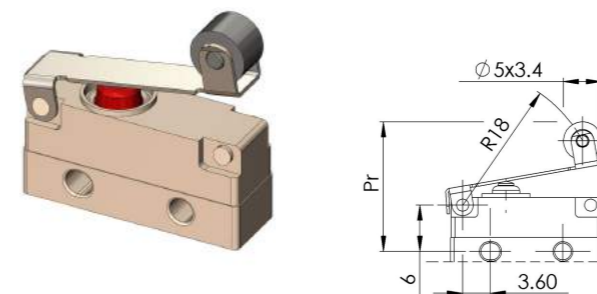

	MP500/550	MP520/570
<b>Actuating Force Fa max. (N)</b>	1.0	0.6
<b>Release Force Fr min. (N)</b>	0.15	0.1
<b>Free Position Pr (mm)</b>	17.2 ± 0.2	17.2 ± 0.4
<b>Operating Position Pa (mm)</b>	16.0 ± 0.2	16.0 ± 0.4
<b>Over-Travel sr min. (mm)</b>	1.2	1.2
<b>Differential Travel sd max. (mm)</b>	0.40	0.40

## Actuator

Type **L81** : Simple Lever with Roller - position B

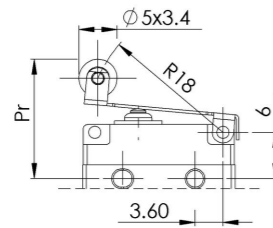
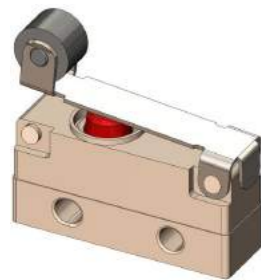

	MP500/550	MP520/570
Actuating Force Fa max. (N)	2.0	1.0
Release Force Fr min. (N)	0.3	0.2
Free Position Pr (mm)	15.7 ± 0.4	15.7 ± 0.4
Operating Position Pa (mm)	15.1 ± 0.4	15.1 ± 0.4
Over-Travel sr min. (mm)	0.6	0.6
Differential Travel sd max. (mm)	0.30	0.30

Type **L85** : Simple Lever with simulated Roller- position A

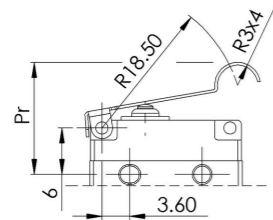
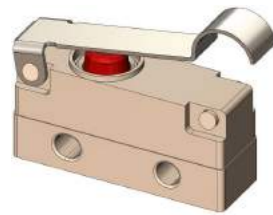

	MP500/550	MP520/570
Actuating Force Fa max. (N)	1.0	0.5
Release Force Fr min. (N)	0.15	0.1
Free Position Pr (mm)	14.7 ± 0.4	14.7 ± 0.4
Operating Position Pa (mm)	13.5 ± 0.4	13.5 ± 0.4
Over-Travel sr min. (mm)	1.2	1.2
Differential Travel sd max. (mm)	0.40	0.40

Type **L86** : Simple Lever with simulated Roller - position B

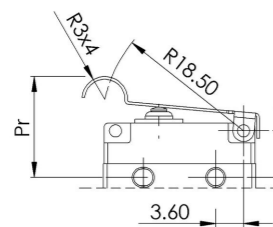
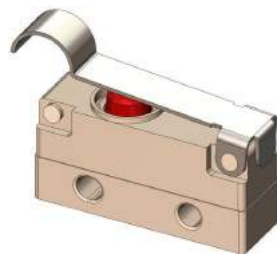

	MP500/550	MP520/570
Actuating Force Fa max. (N)	2.0	0.6
Release Force Fr min. (N)	0.3	0.2
Free Position Pr (mm)	13.2 ± 0.4	13.2 ± 0.4
Operating Position Pa (mm)	12.6 ± 0.4	12.6 ± 0.4
Over-Travel sr min. (mm)	0.6	0.6
Differential Travel sd max. (mm)	0.30	0.30

## Version light force : MP520/MP570

For applications requiring a light actuating force, for example pressure switches, the Series MP500 offers a version with a modified spring force. All other parameters - dimension, electrical rating and IP protection remain unchanged.

## Version IP40 MP550/MP570

For applications where IP protection is not an issue, the Series MP500 offers a version without the sealing membrane.

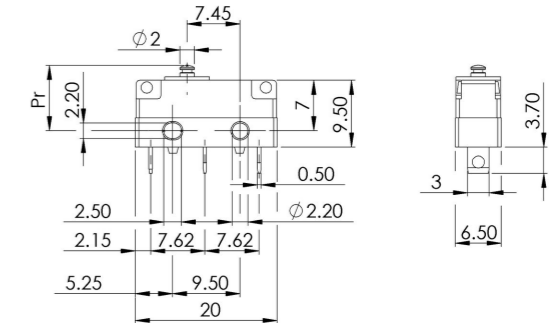

## Electrical Circuit

	Connection Code	Circuit	Color - Code
Solder Lugs PCB	<b>C000</b> <b>C001</b>		
PVC Cable	<b>C10.</b> / <b>C20.</b>		1 - Black 2 - Grey 4 - Blue 

## Ordering Information

	MP5	0	0	-	L70	-	C100
<b>Housing</b>							
0:	IP67						
2:	IP67 Low force						
5:	IP40						
7:	IP40 Low force						
<b>Contact</b>							
0:	Silver Contact						
1:	Gold Contact						
<b>Actuator</b>							
0:	Basic switch - Pin Button						
L70:	Simple Lever - position A						
L71:	Simple Lever - position B						
L80:	Simple Lever with Roller - position A						
L81:	Simple Lever with Roller - position B						
L85:	Simple Lever with simulated Roller - position A						
L86:	Simple Lever with simulated Roller - position B						
<b>Connection</b>							
C000:	Solder Lugs 250VAC/5A						
C001:	PCB 250VAC/5A						
C100:	Cable PVC, 3x0.25mm <sup>2</sup> , 250VAC 2A 0.5 (m)						
C101:	Cable PVC, 3x0.25mm <sup>2</sup> , 250VAC 2A 1 (m)						
C102:	Cable PVC, 3x0.25mm <sup>2</sup> , 250VAC 2A 2 (m)						
C200:	Cable PVC, 3x0.50mm <sup>2</sup> , 250VAC 5A 0.5 (m)						
C201:	Cable PVC, 3x0.50mm <sup>2</sup> , 250VAC 5A 1 (m)						
C202:	Cable PVC, 3x0.50mm <sup>2</sup> , 250VAC 5A 2 (m)						

## Explore our other products

### IP67 Position Switches

The position switches are IP67 sealed, they have a forced break opening and are fulfilling EN60947-5-1. The cable is directly overmoulded into the metal or plastic housing. These switches are available with a wide range of actuators.



### Safety Switches

These switches with metal or plastic housing are adapted solutions for emergency stop applications. The forced break opening allows safety applications under EN60947-5-1.



### LED Indicators

These LED indicator lights fulfill the high expectations of industrial applications. Wilbrecht LEDCO designs and manufactures products in metal or plastic housings and can support you with adapted solutions from concept through the final application.



### LED Bars

The LED bars from Wilbrecht LEDCO allow you a customized solution to your specifications without tooling charges. Variable LED spacing and color combinations can be assembled in a single bar to your requirement.

